

ADMIN

FACULTY

STAFF

STUDENT

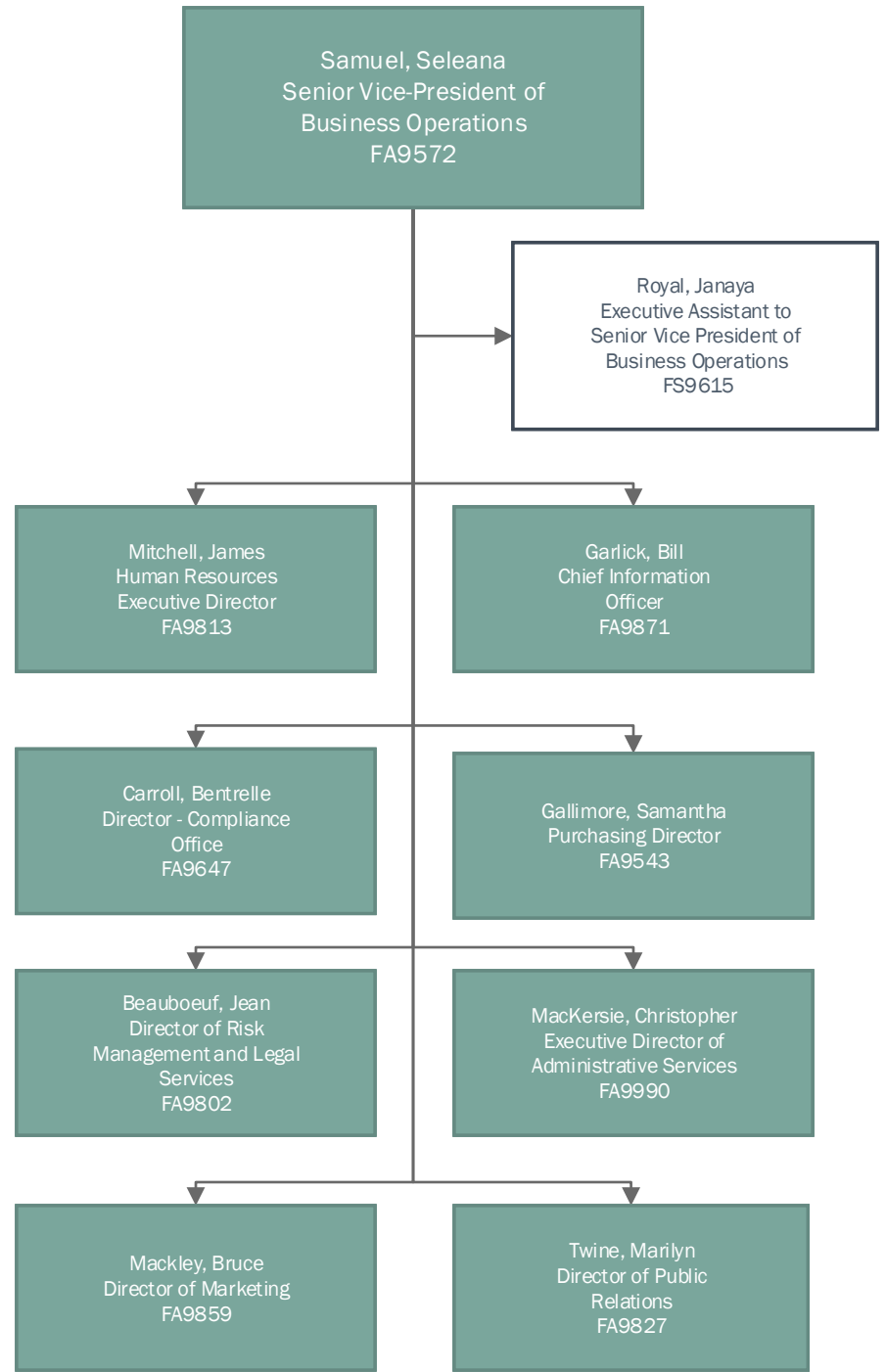

ADMIN

FACULTY

STAFF

STUDENT

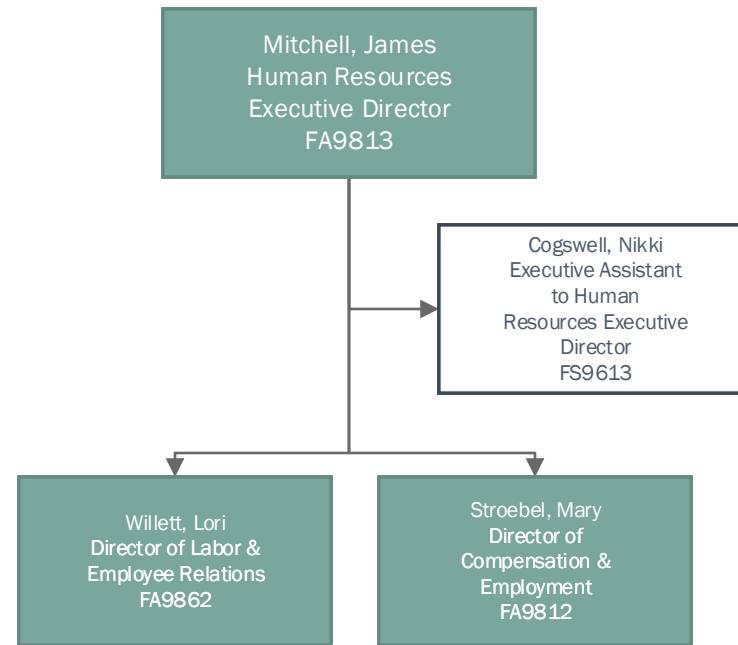

ADMIN

FACULTY

STAFF

STUDENT

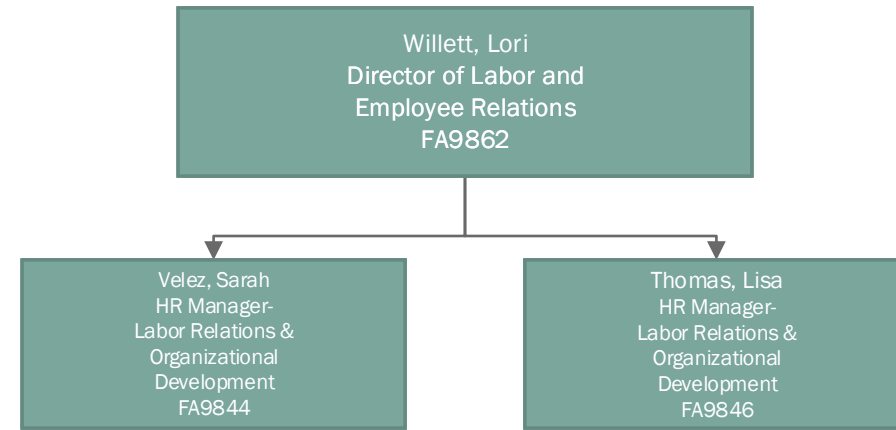

ADMIN

FACULTY

STAFF

STUDENT

Velez, Sarah  
HR Manager-  
Labor Relations &  
Organizational Development  
FA9844



Hufnagel, Eric  
Instructional Designer  
& Organizational  
Development Specialist  
FS9756

ADMIN

FACULTY

STAFF

STUDENT

Thomas, Lisa  
HR Manager-  
Labor Relations &  
Organizational Development  
FA9846

Villarreal, Jessica  
HR Employee Relations  
& Student Employment  
Specialist  
FS9657



ADMIN

FACULTY

STAFF

STUDENT

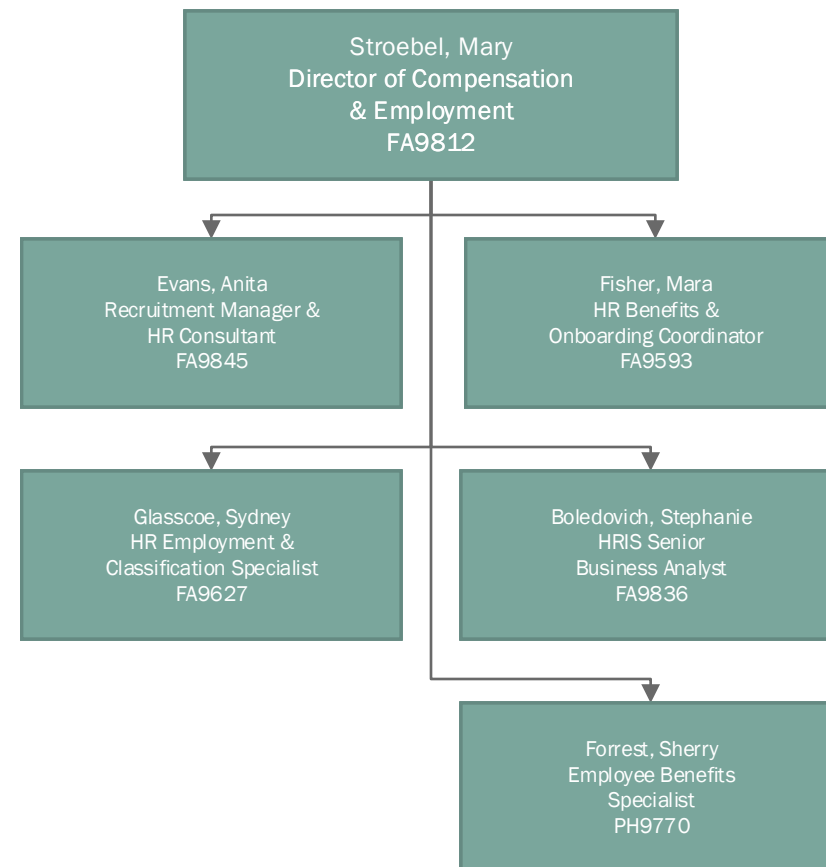

ADMIN

FACULTY

STAFF

STUDENT

Evans, Anita  
Recruitment Manager  
& HR Consultant  
FA9845



Butterwick, Angela  
Human Resources  
Assistant  
FS9782

ADMIN

FACULTY

STAFF

STUDENT

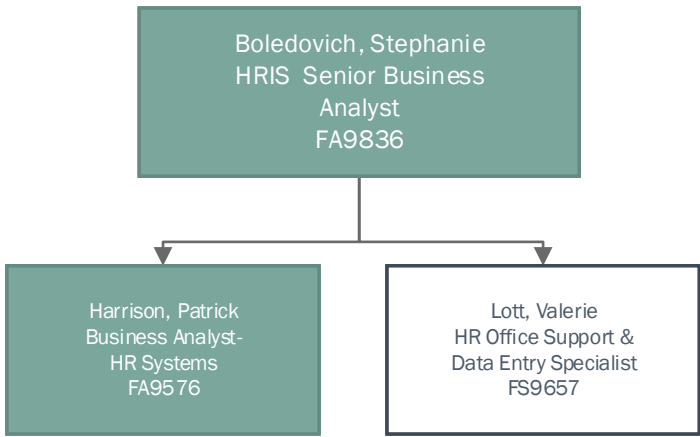



ADMIN

FACULTY

STAFF

STUDENT

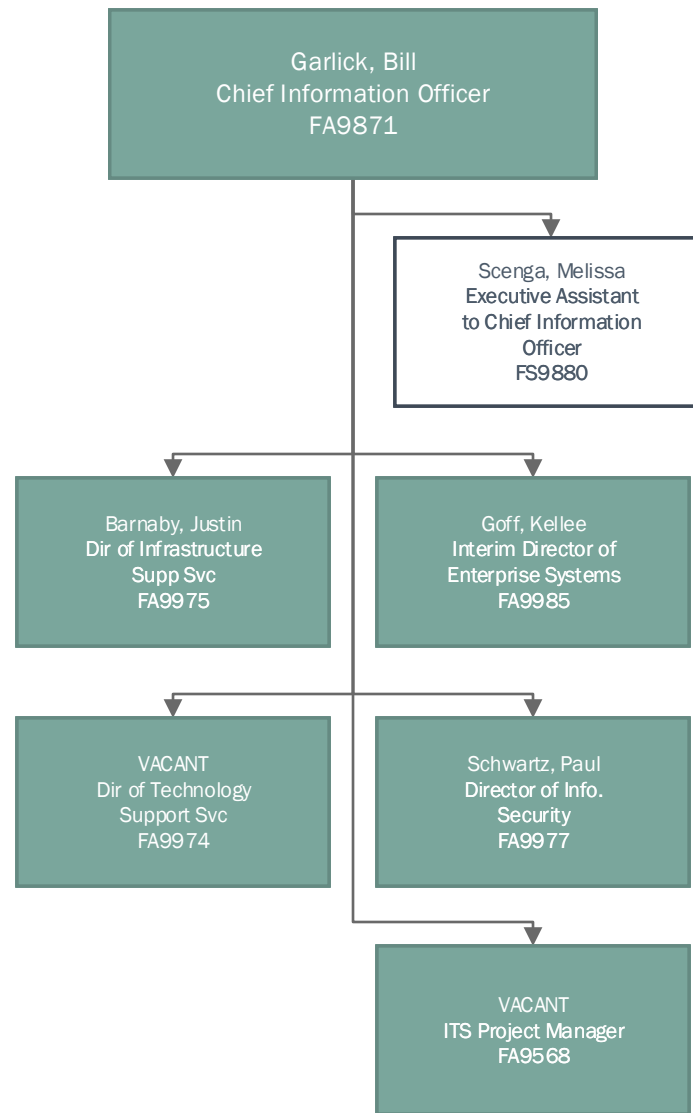

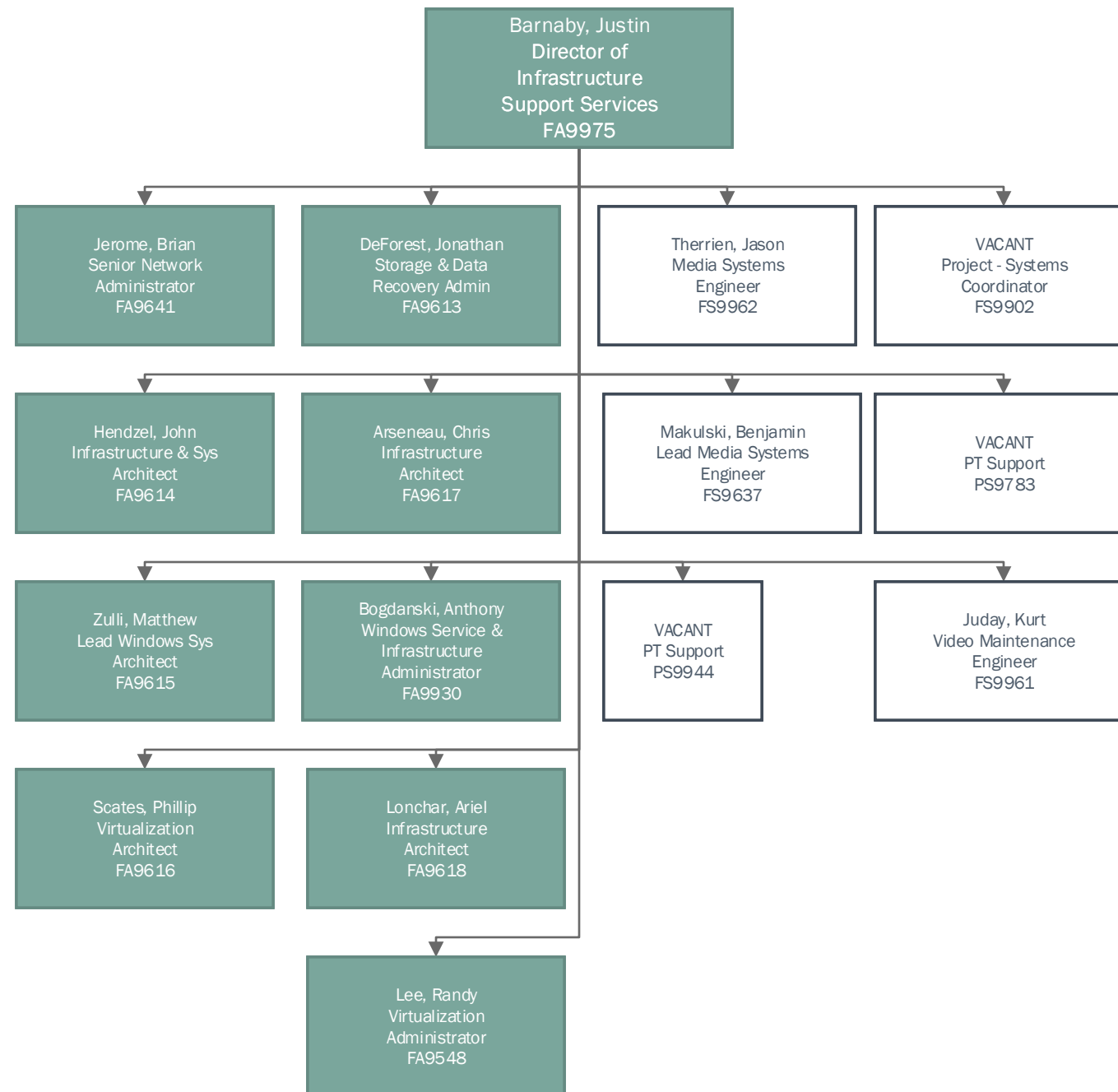
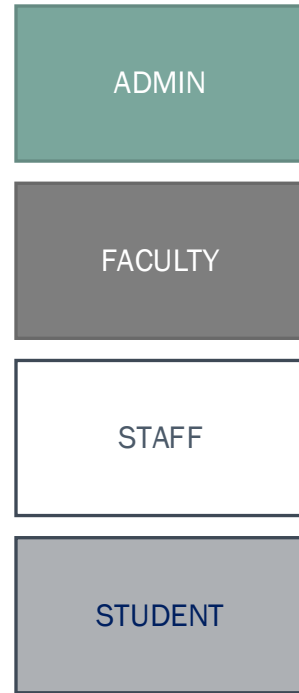

ADMIN

FACULTY

STAFF

STUDENT

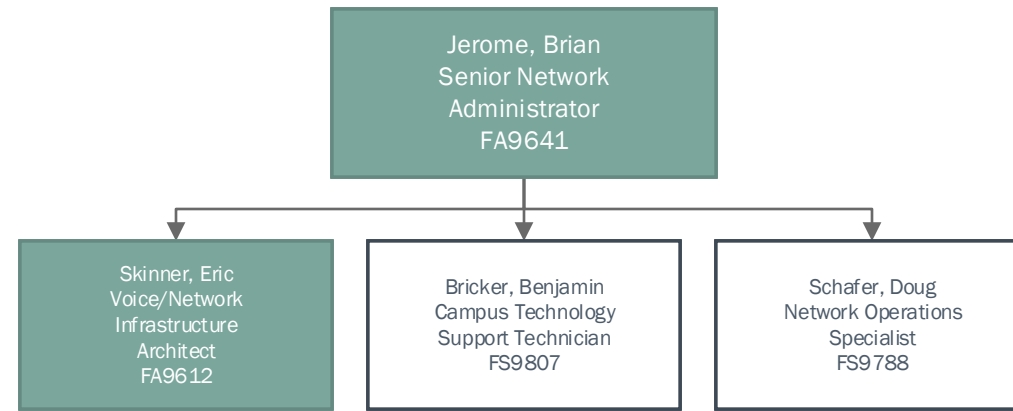

ADMIN

FACULTY

STAFF

STUDENT

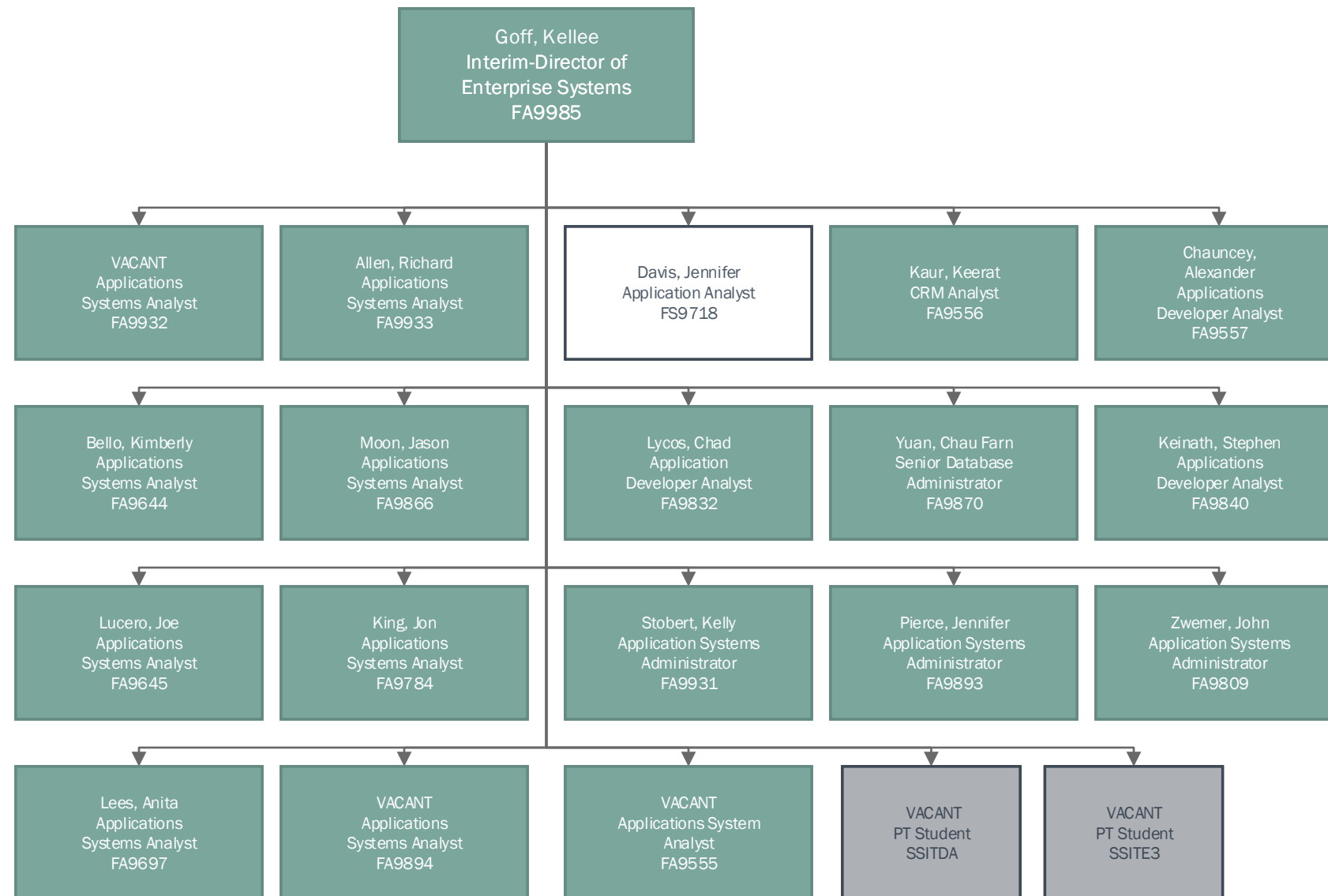

ADMIN

FACULTY

STAFF

STUDENT

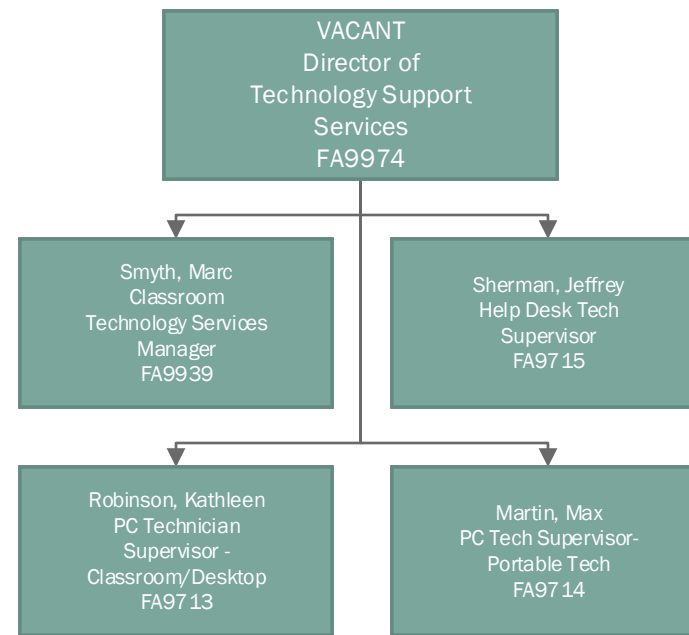

ADMIN

FACULTY

STAFF

STUDENT

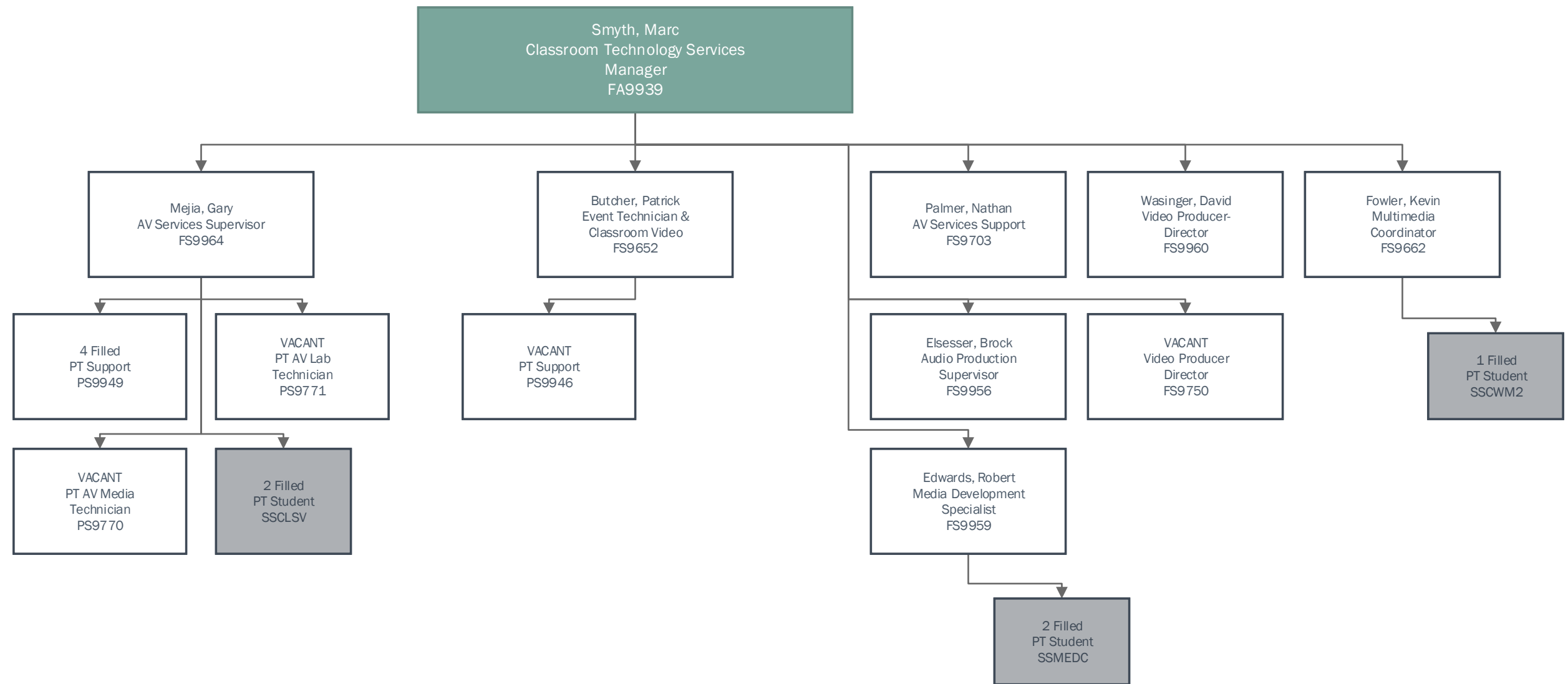

ADMIN

FACULTY

STAFF

STUDENT

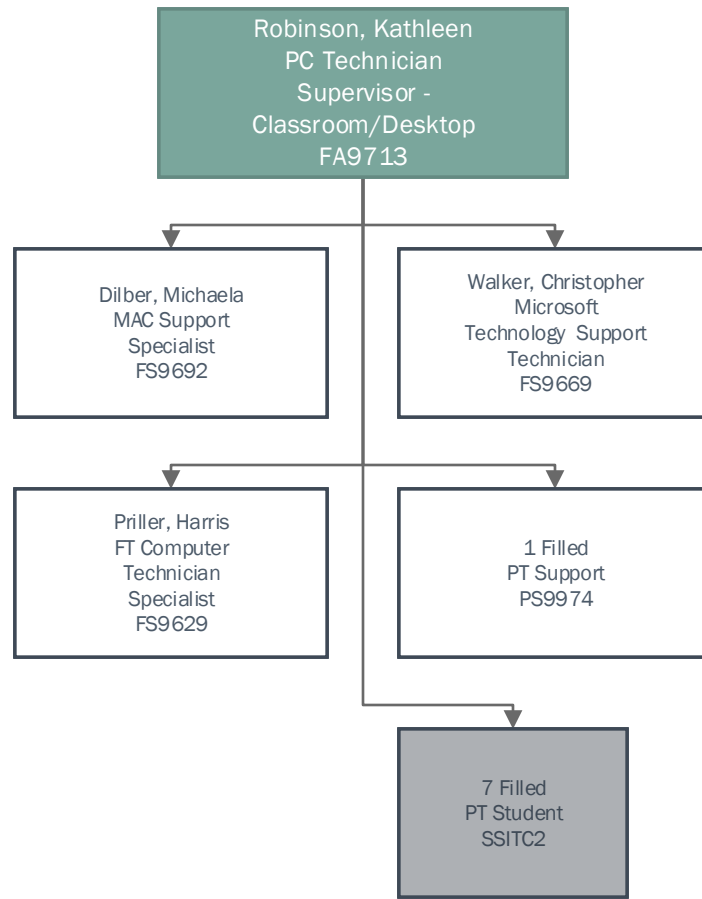

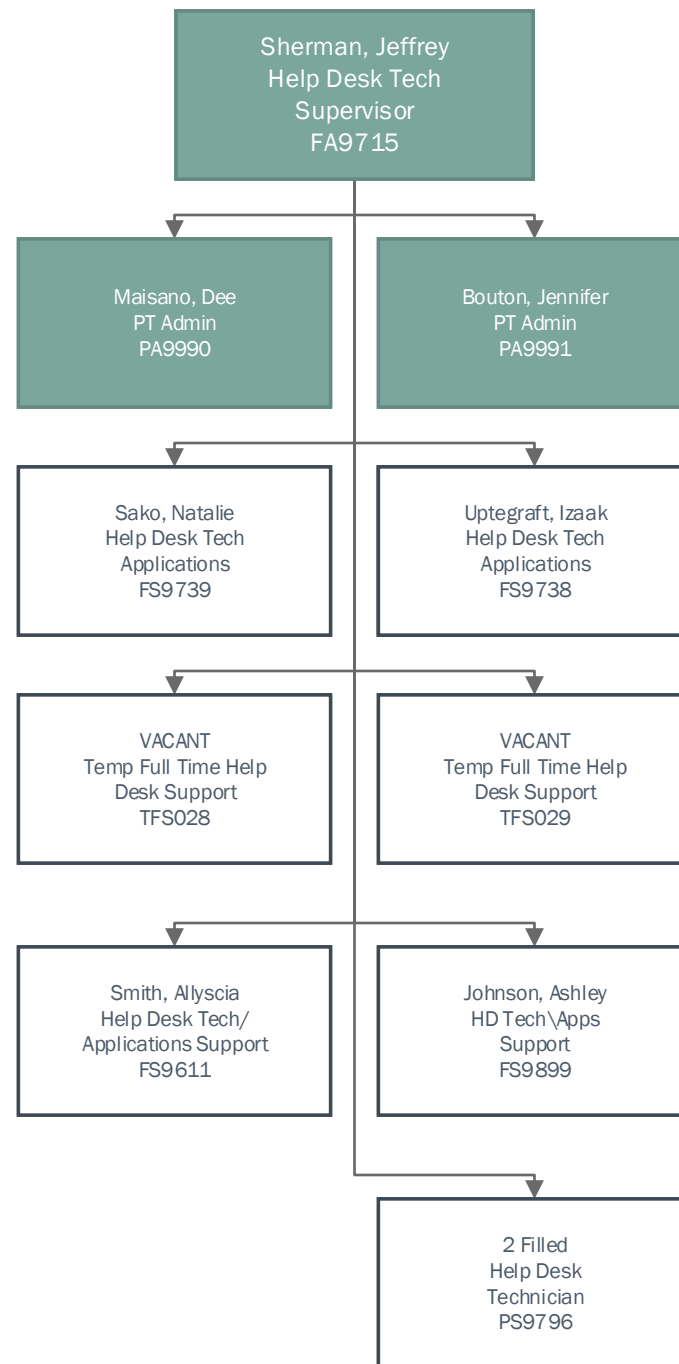
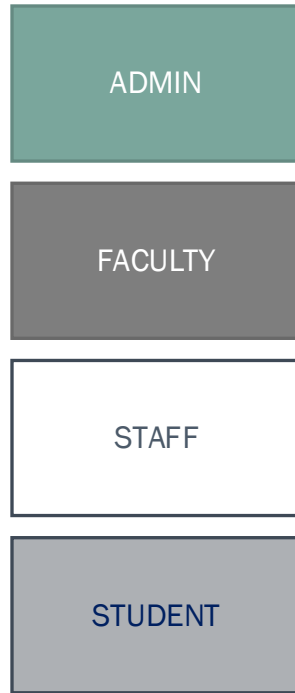



ADMIN

FACULTY

STAFF

STUDENT

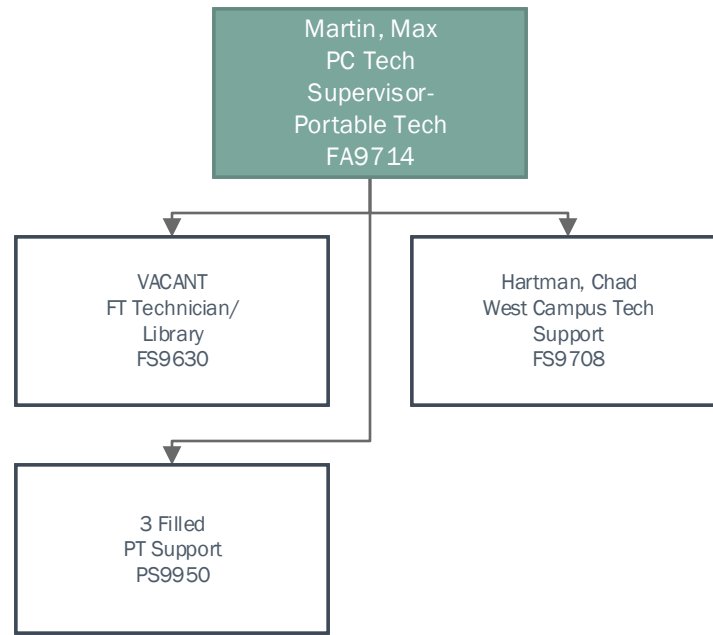

ADMIN

FACULTY

STAFF

STUDENT

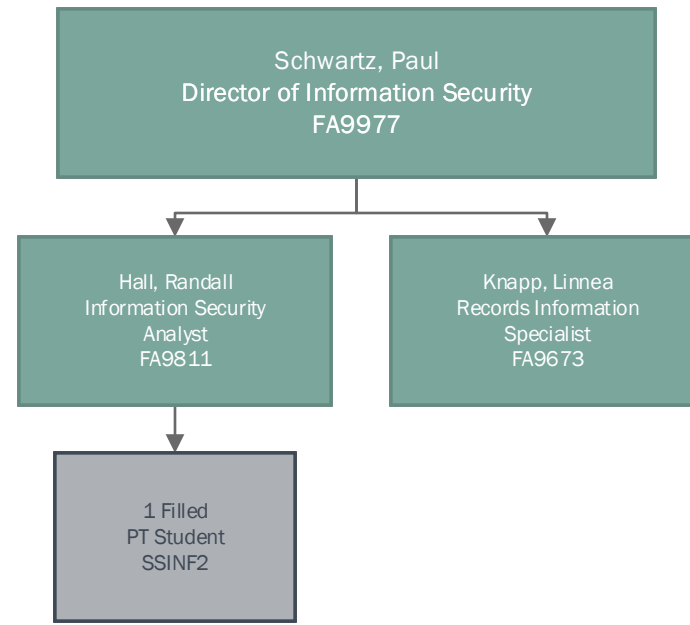

ADMIN

FACULTY

STAFF

STUDENT

Carroll, Bentrelle  
Director - Compliance  
Office  
FA9647



VACANT  
PT Student  
SSCMP2

- ADMIN
- FACULTY
- STAFF
- STUDENT

