

- ADMIN
- FACULTY
- STAFF
- STUDENT

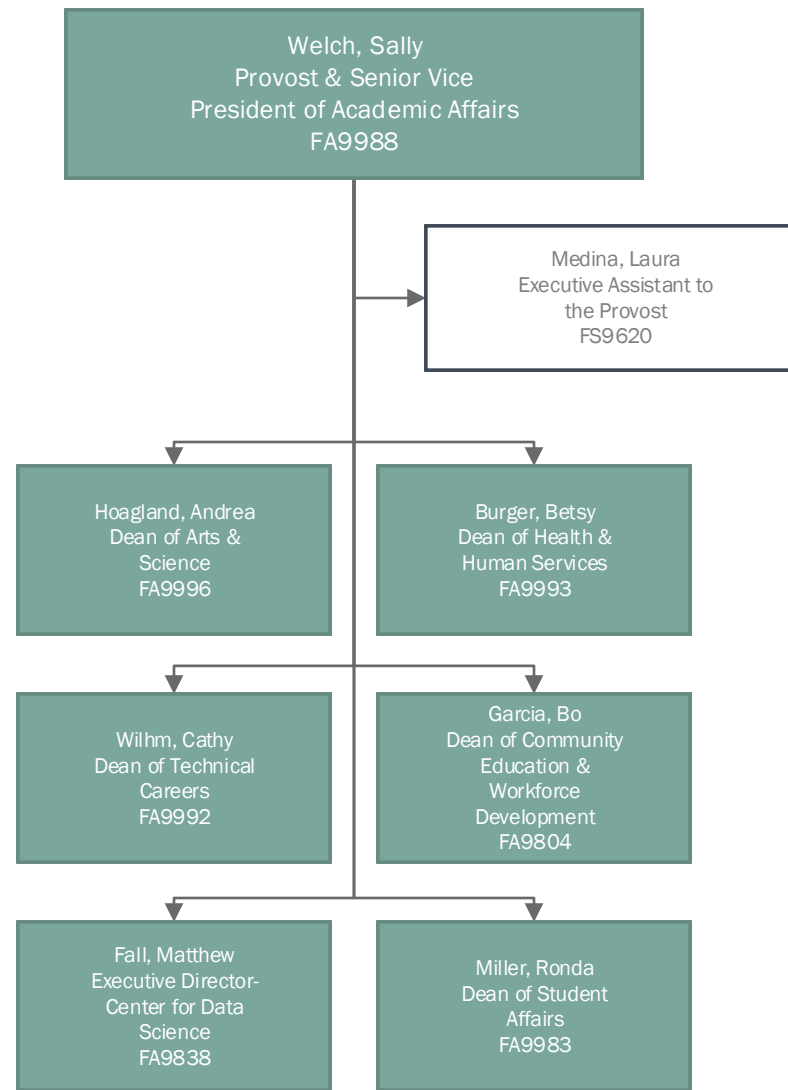

ADMIN

FACULTY

STAFF

STUDENT

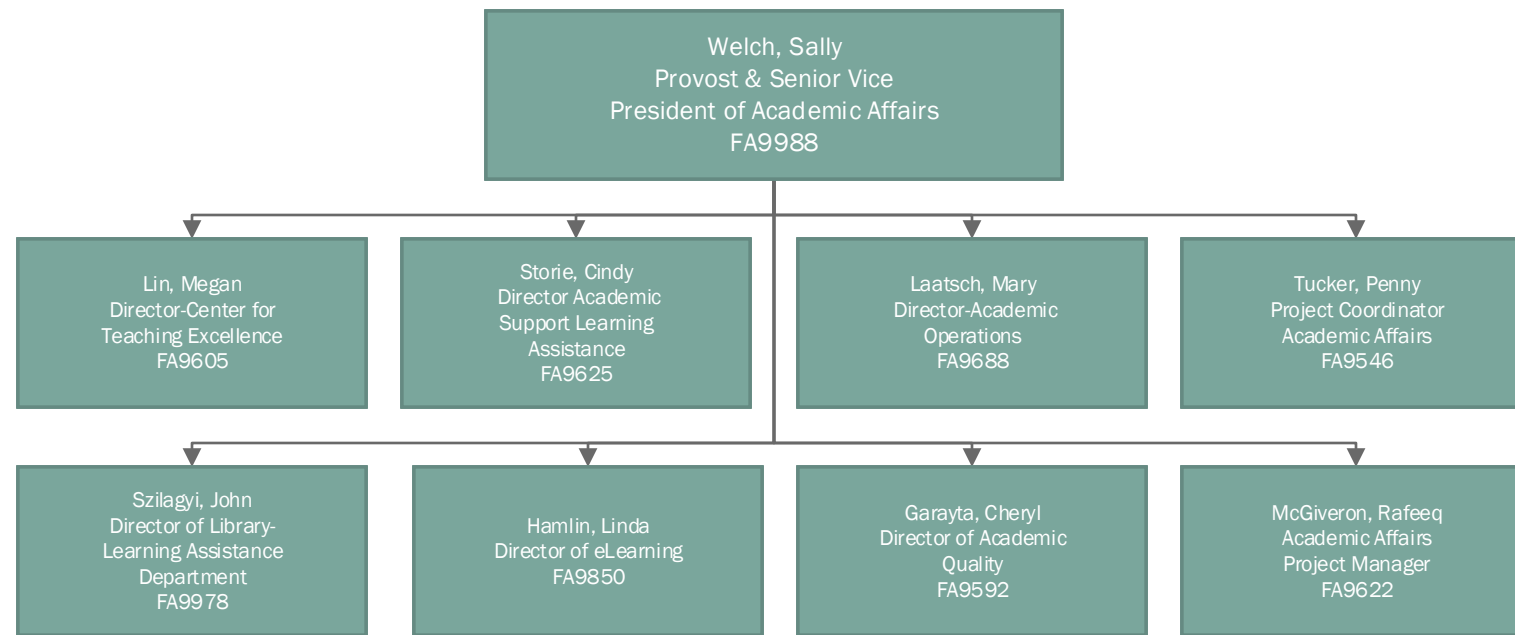

ADMIN

FACULTY

STAFF

STUDENT

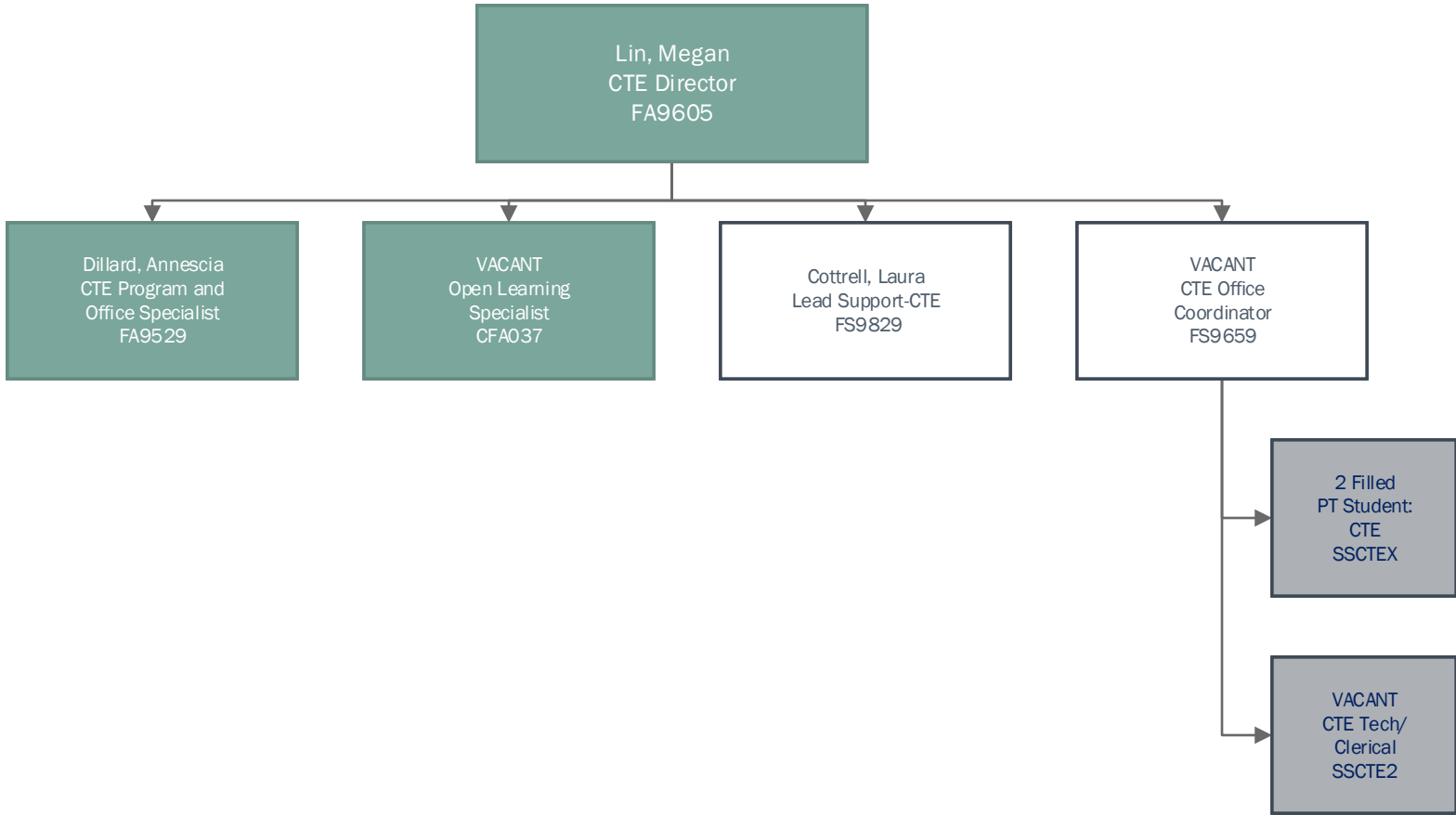

ADMIN

FACULTY

STAFF

STUDENT

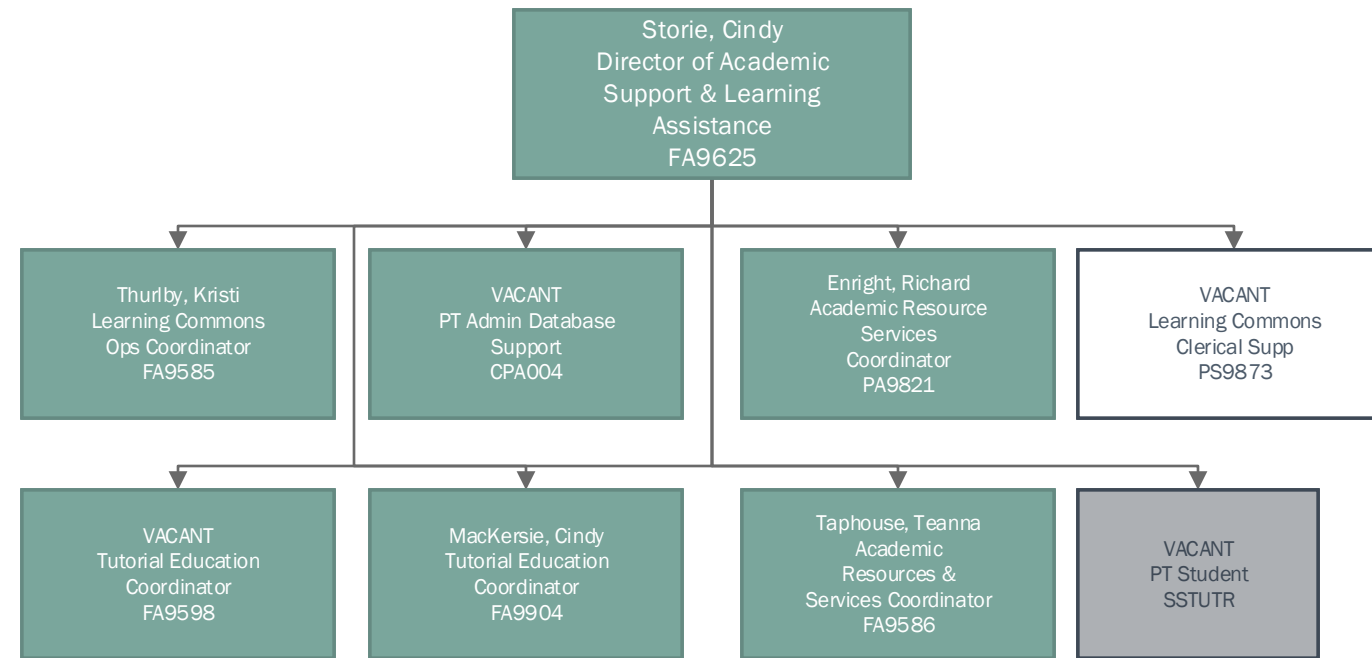

ADMIN

FACULTY

STAFF

STUDENT

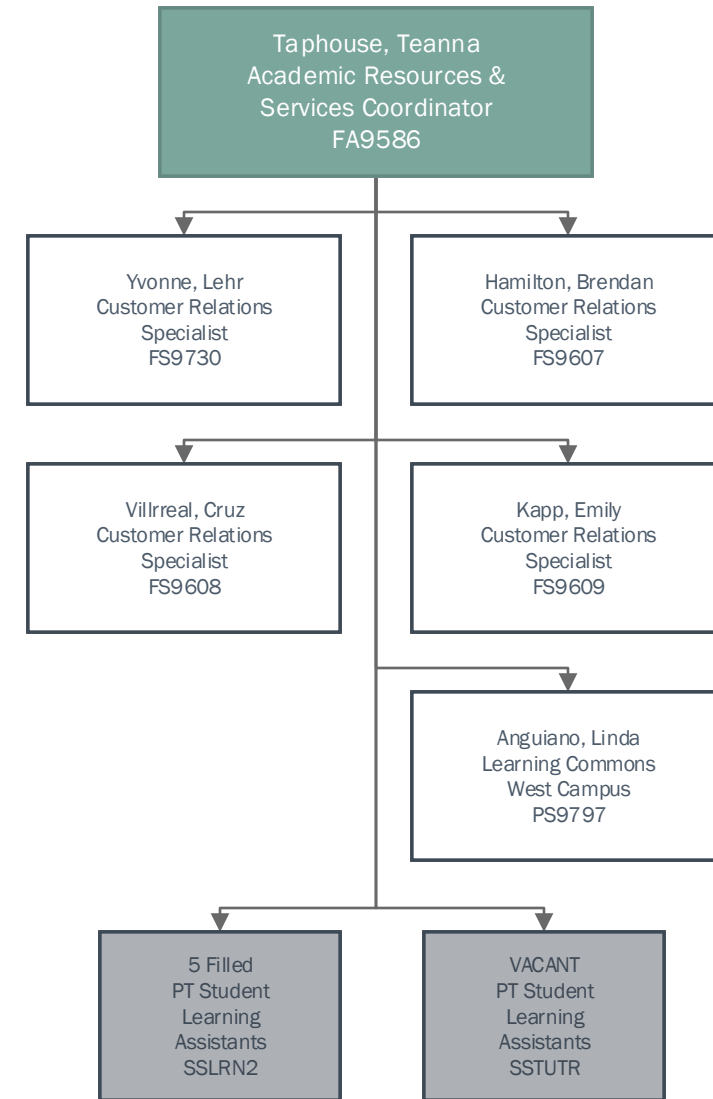

ADMIN

FACULTY

STAFF

STUDENT

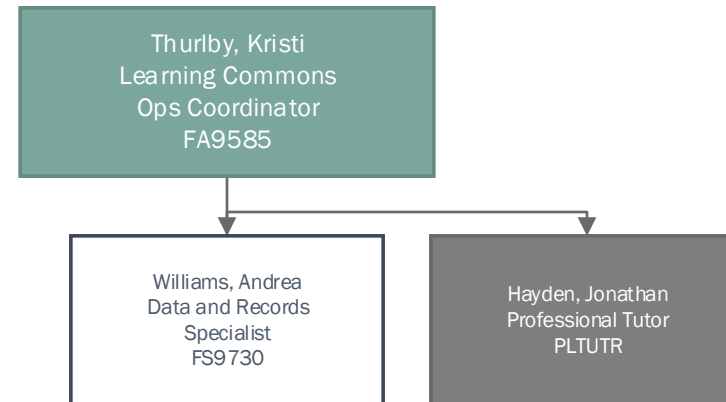

ADMIN

FACULTY

STAFF

STUDENT

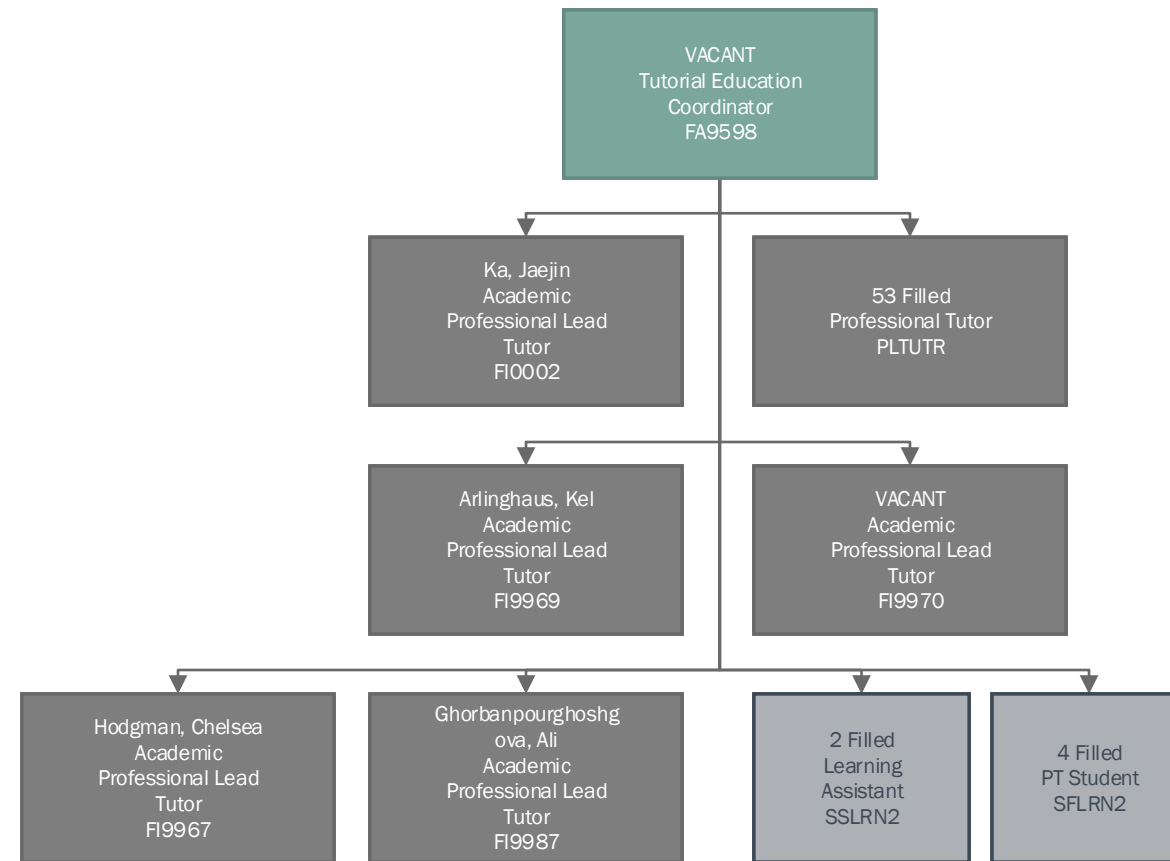

ADMIN

FACULTY

STAFF

STUDENT

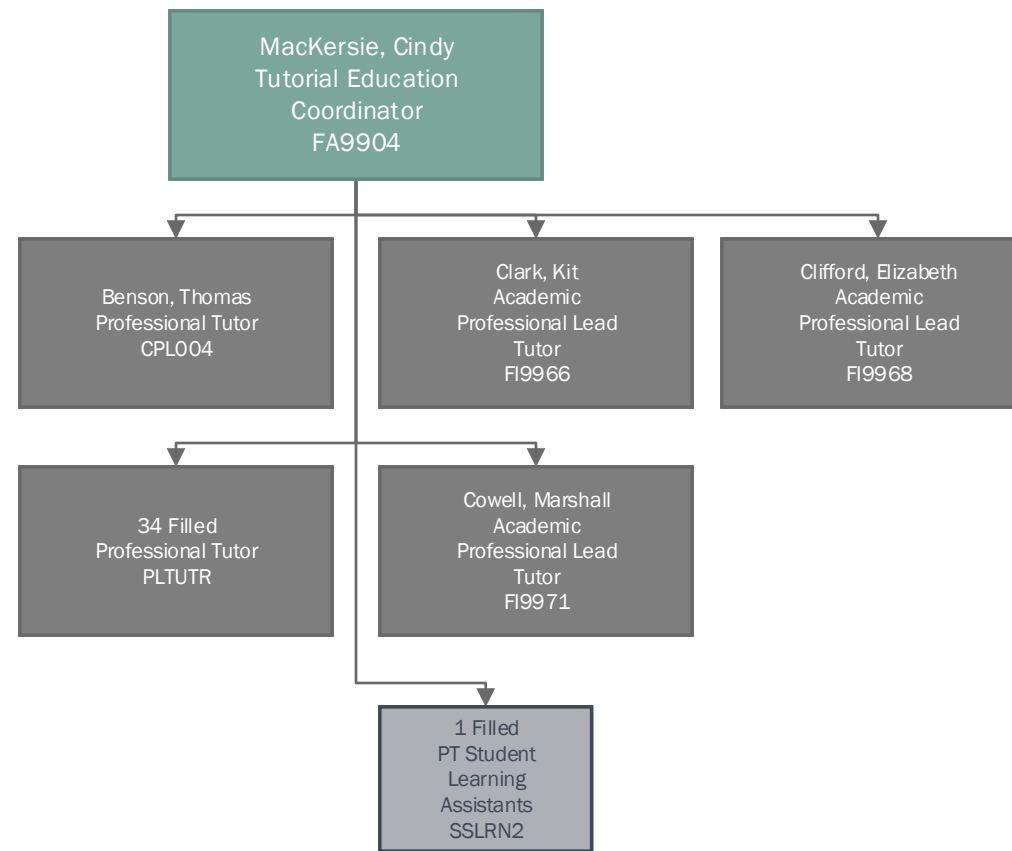



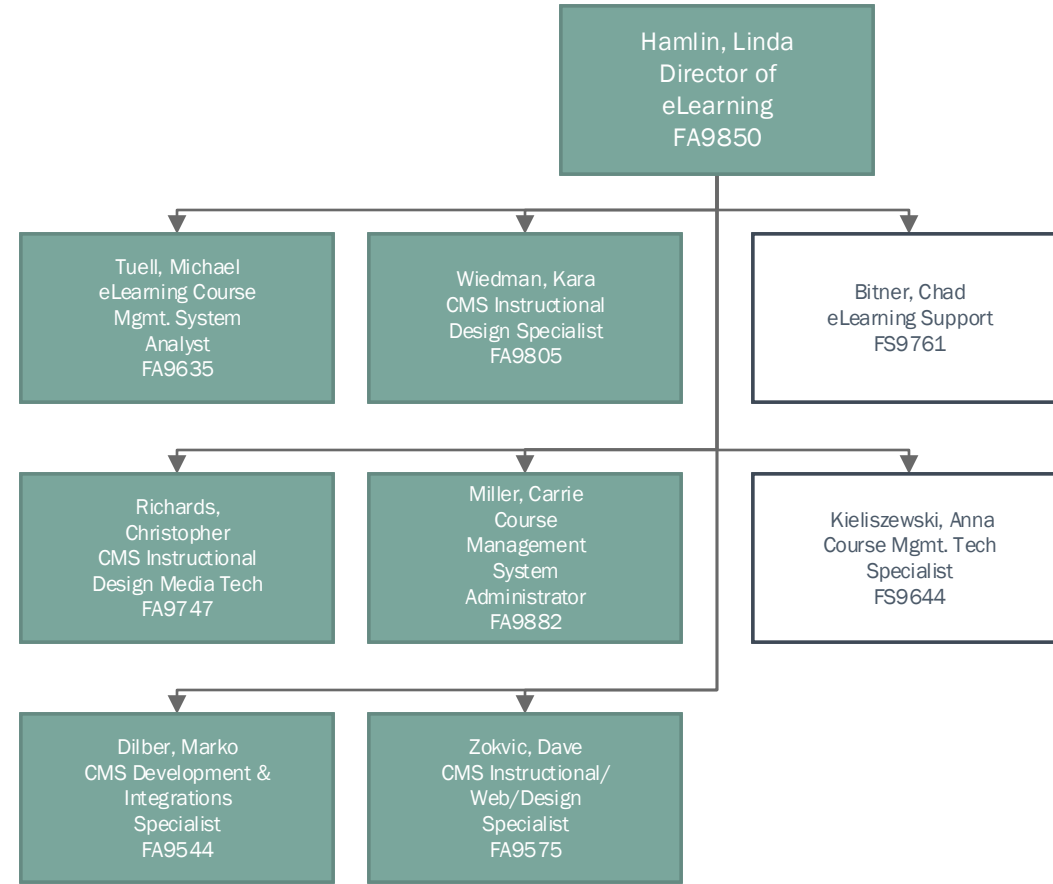
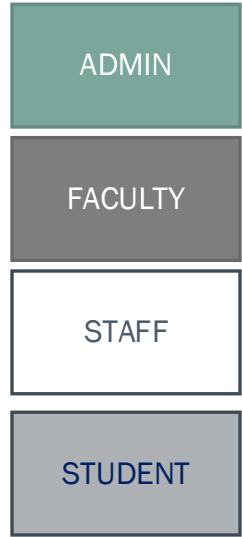

ADMIN

FACULTY

STAFF

STUDENT

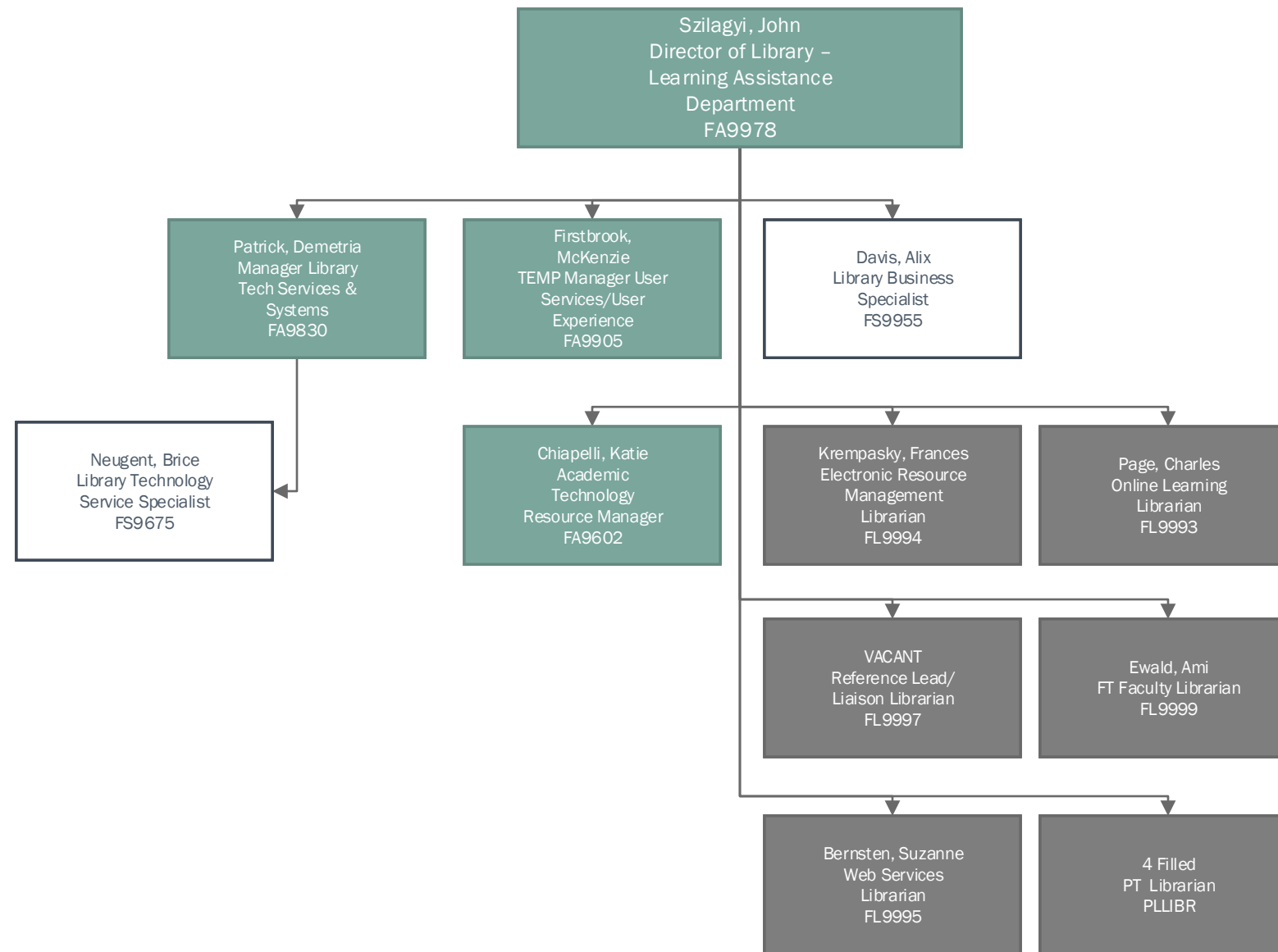

ADMIN

FACULTY

STAFF

STUDENT

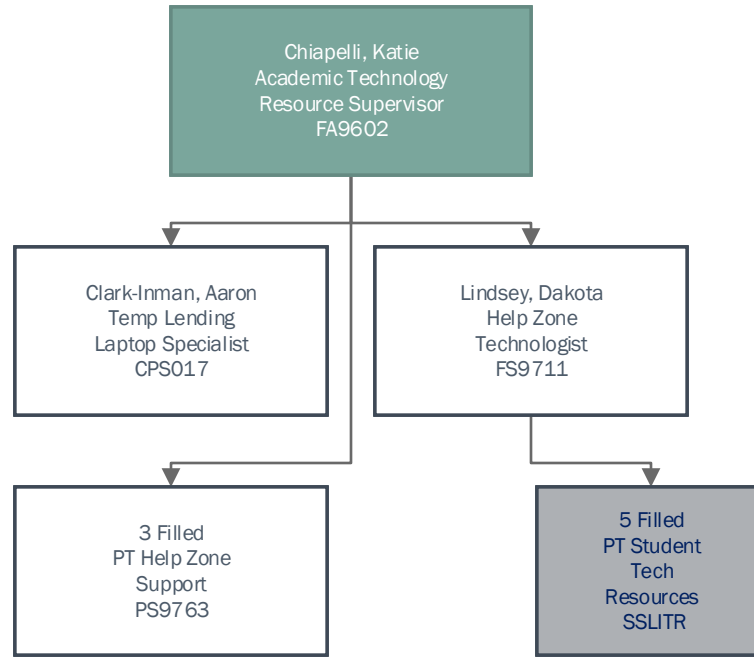

- ADMIN
- FACULTY
- STAFF
- STUDENT

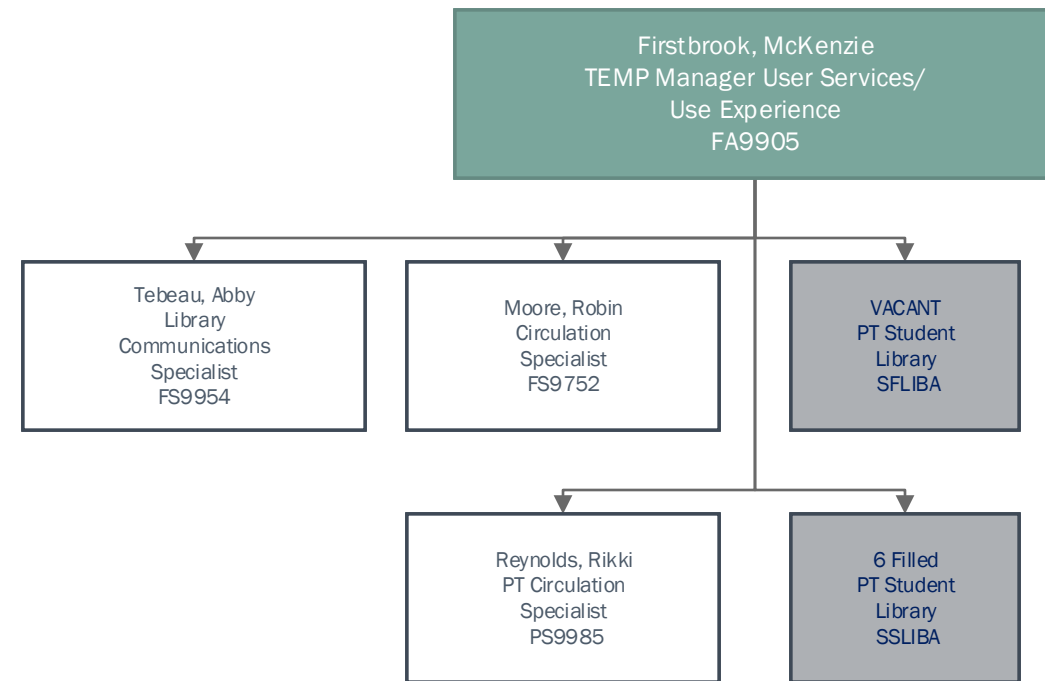

ADMIN

FACULTY

STAFF

STUDENT

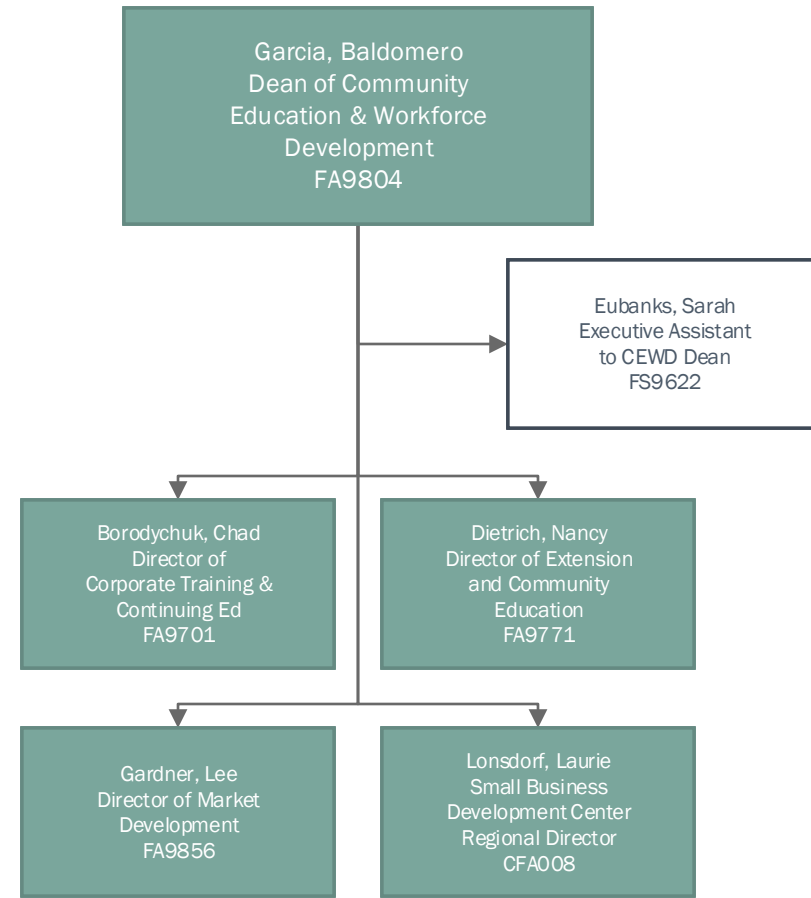

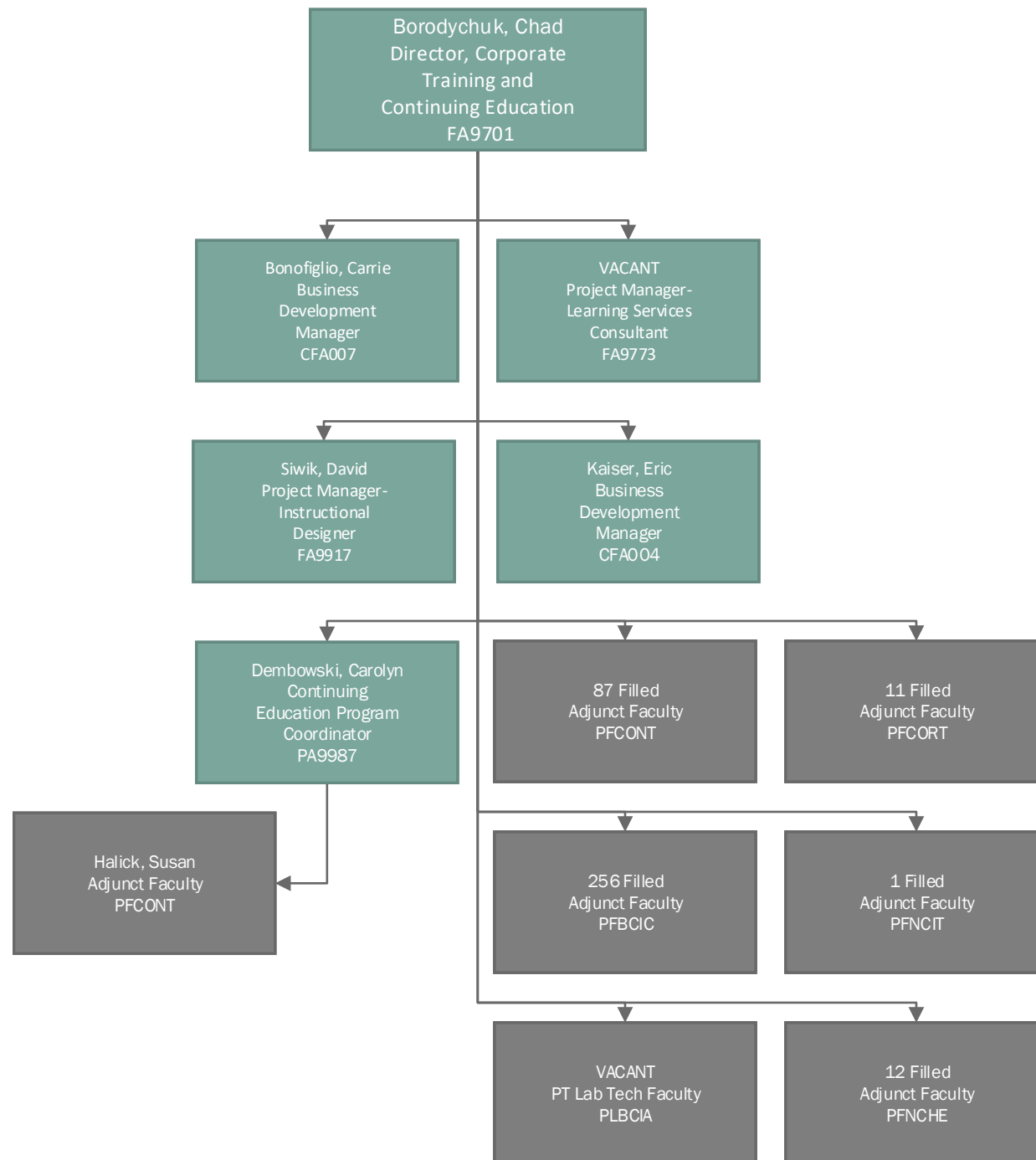
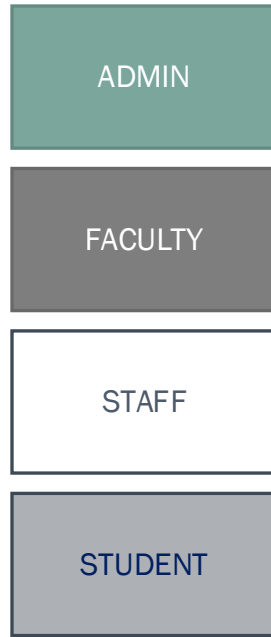

ADMIN

FACULTY

STAFF

STUDENT

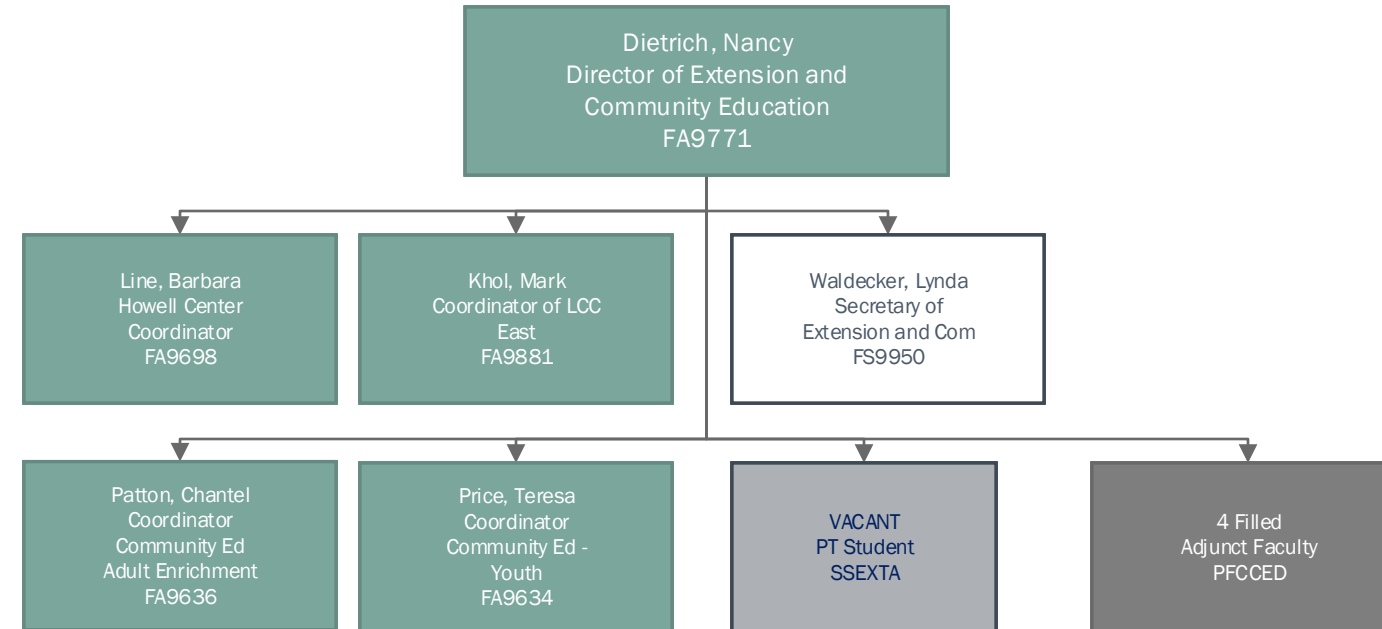

- ADMIN
- FACULTY
- STAFF
- STUDENT

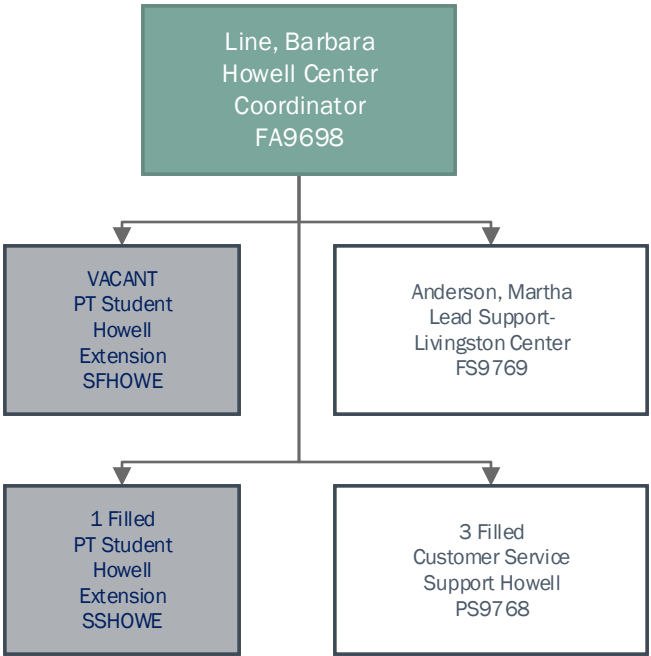



ADMIN

FACULTY

STAFF

STUDENT

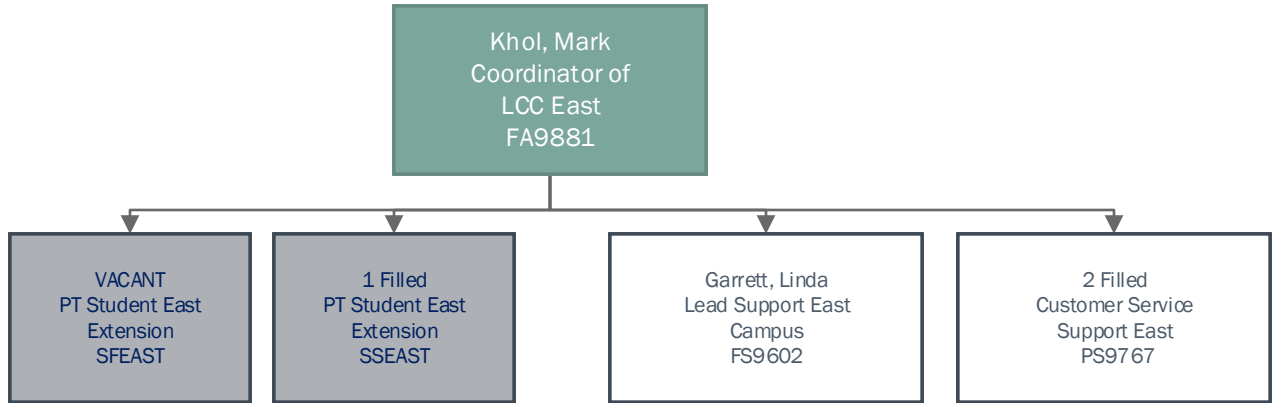

- ADMIN
- FACULTY
- STAFF
- STUDENT

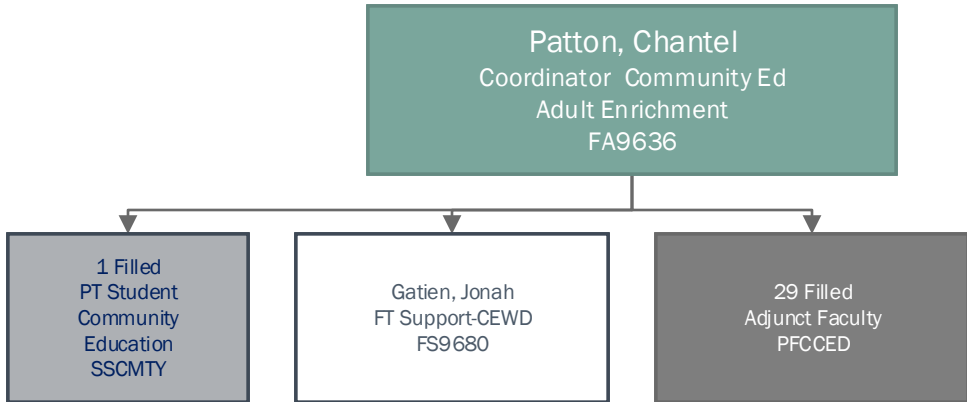

- ADMIN
- FACULTY
- STAFF
- STUDENT

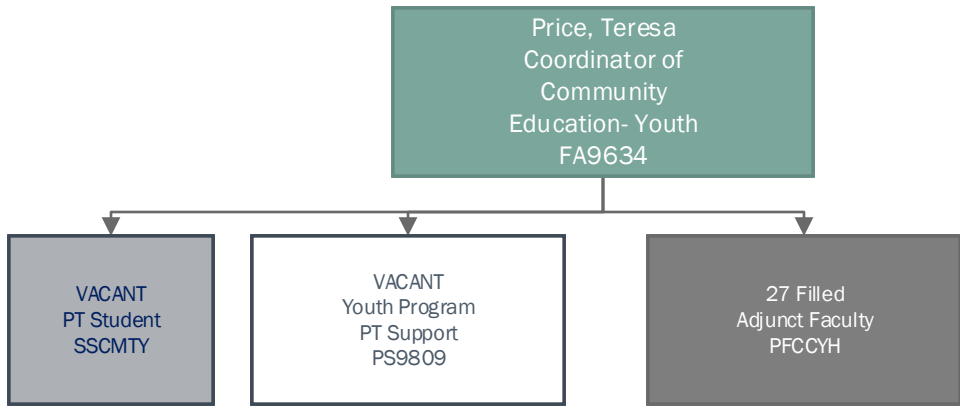

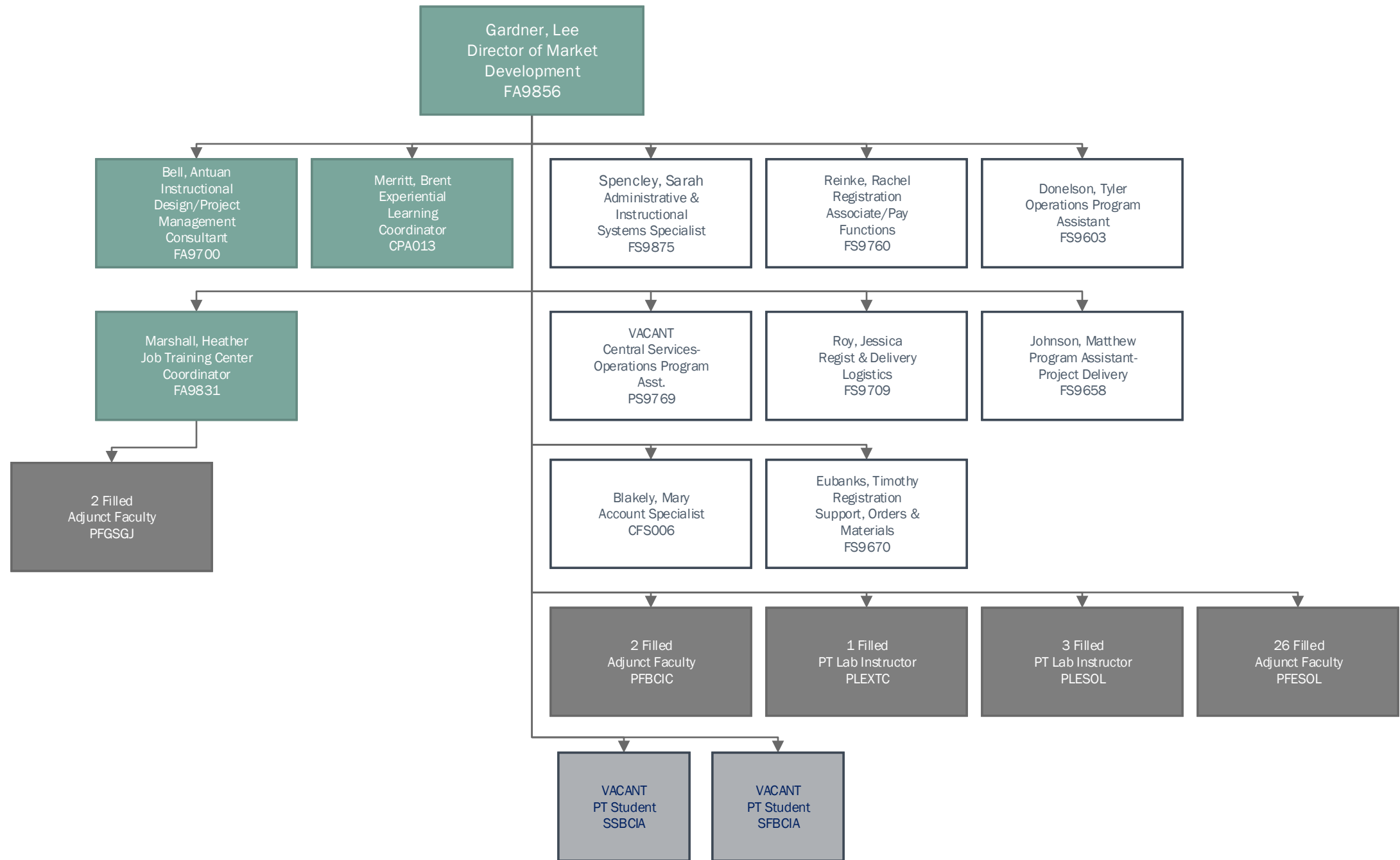
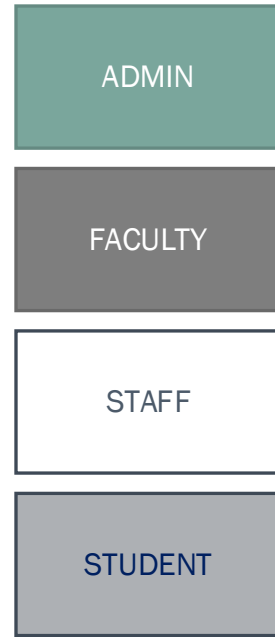

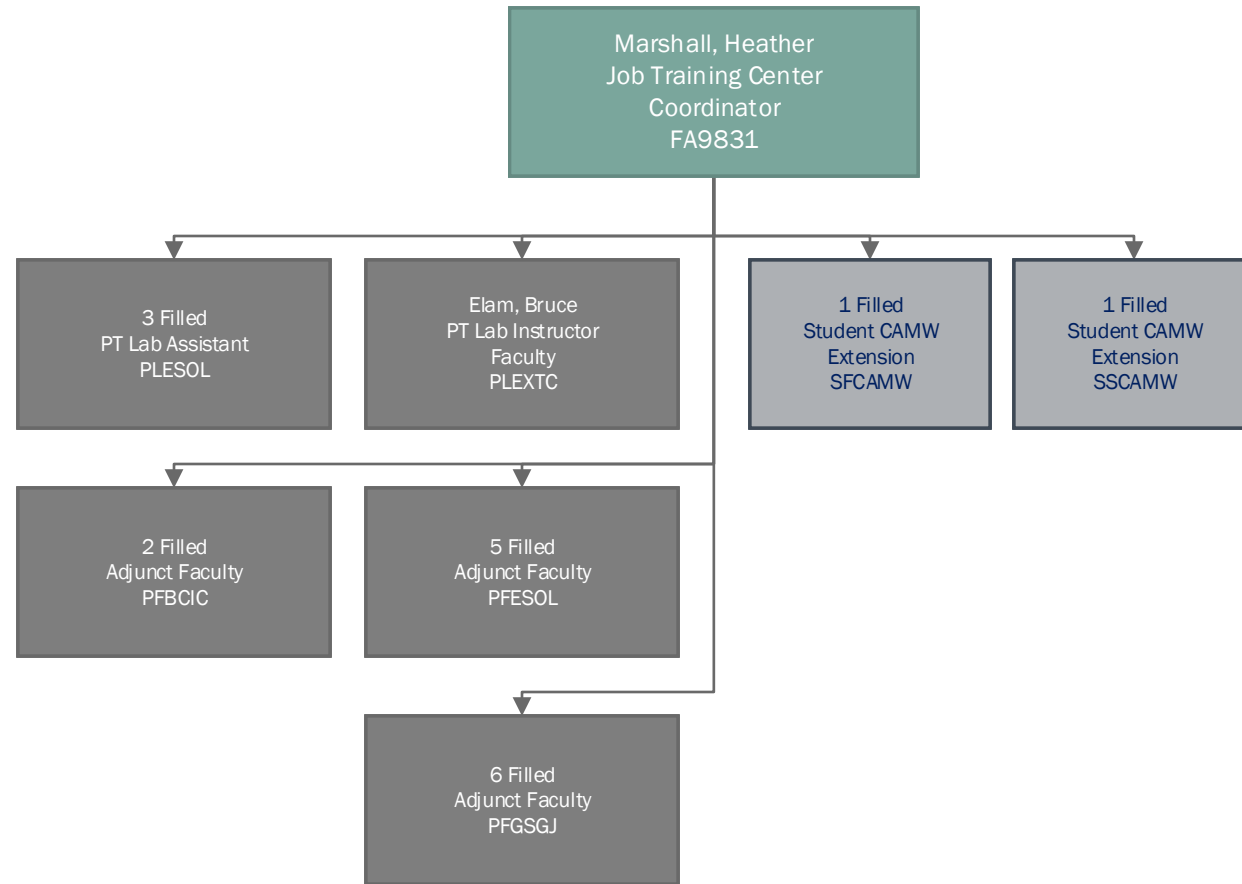
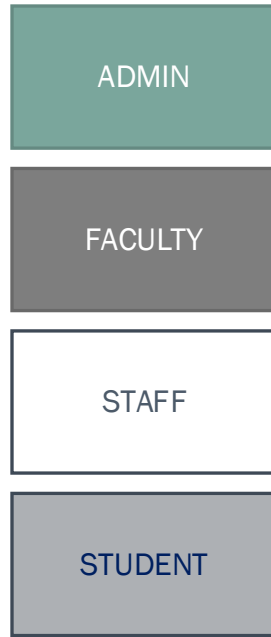

- ADMIN
- FACULTY
- STAFF
- STUDENT

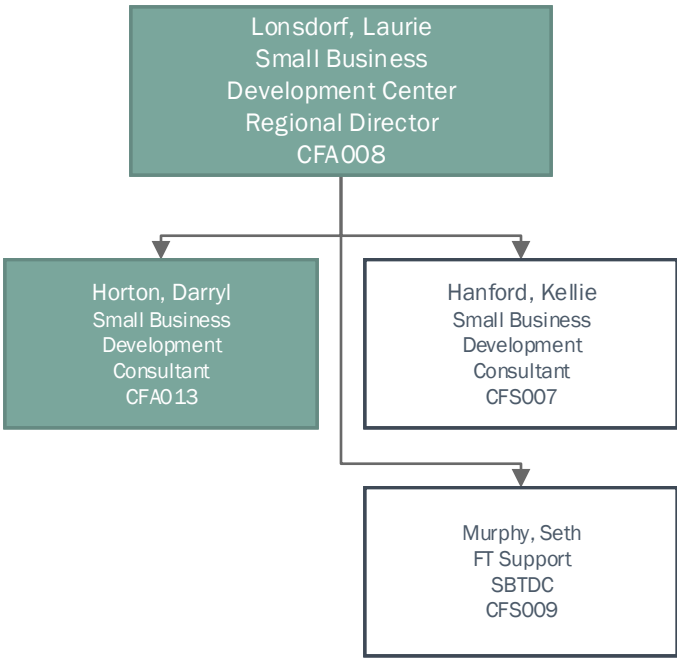

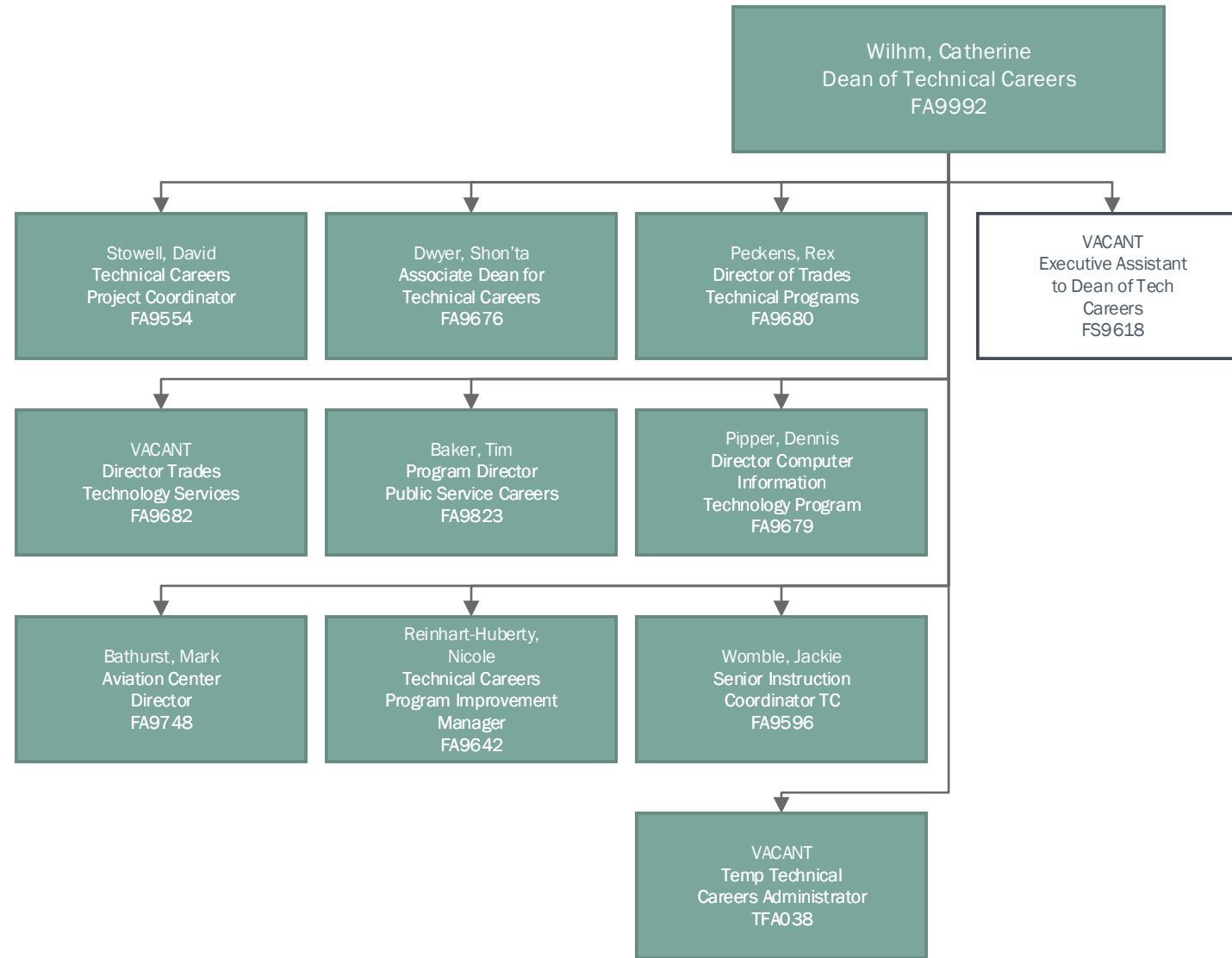
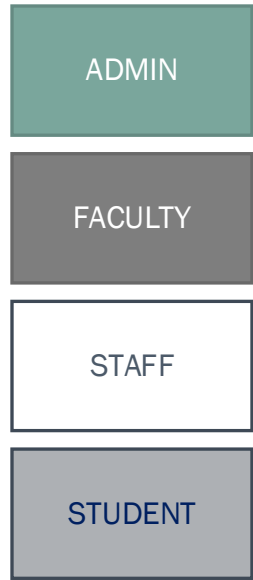

ADMIN

FACULTY

STAFF

STUDENT

Dwyer, Shon'ta  
Associate Dean for  
Technical Careers  
FA9676

LaFleur, Danielle  
Technical Careers  
Operations  
Coordinator  
FA9677

VACANT  
FT Support  
Evening College/  
Operations  
FS9764

VACANT  
PT Support  
PS9893

Meyers, Carson  
Academic  
Professional-  
ERESA  
ELAUTO

Morrison, Roger  
Academic  
Professional  
PIWELD

2 Filled  
Adjunct Faculty  
PFAEET

6 Filled  
Adjunct Faculty  
PFARCH

4 Filled  
Adjunct Faculty  
PFAUTB

8 Filled  
Adjunct Faculty  
PFAUTO

5 Filled  
Adjunct Faculty  
PFBLDT

14 Filled  
Adjunct Faculty  
PFHVAC

8 Filled  
Adjunct Faculty  
PFCIVL

3 Filled  
Adjunct Faculty  
PFELTE

1 Filled  
Academic  
Professional  
PLBLDT

31 Filled  
Adjunct Faculty  
PFCITX

4 Filled  
Adjunct Faculty  
PFTECH

9 Filled  
Adjunct Faculty  
PFGRET

1 Filled  
Academic  
Professional  
PLHVAC

2 Filled  
Adjunct Faculty  
PFHERE

14 Filled  
Adjunct Faculty  
PFHVAC

3 Filled  
Academic  
Professional  
PLMETX

1 Filled  
Academic  
Professional  
PIMETX

1 Filled  
Academic  
Professional  
PLHVAC

15 Filled  
Adjunct Faculty  
PFMETX

8 Filled  
Adjunct Faculty  
PFWELD

2 Filled  
Academic  
Professional  
PLWELD

VACANT  
PT Student  
SSAUT2

1 Filled  
PT Student  
SSBLD2

1 Filled  
PT Student  
SSMET2

1 Filled  
PT Student  
SSUTE2



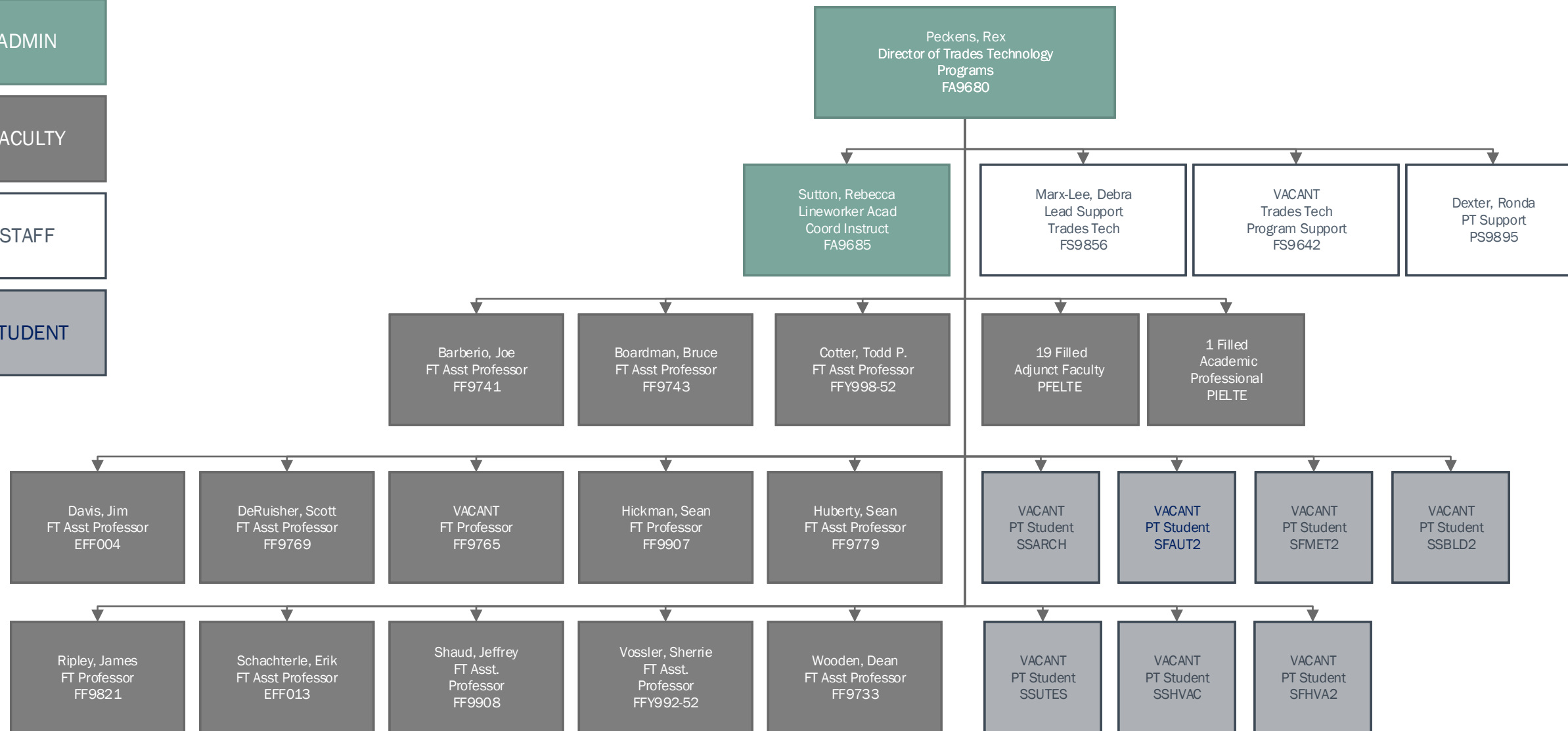
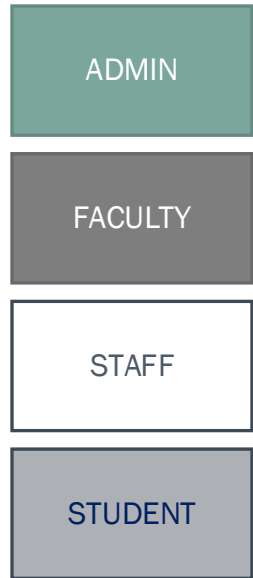

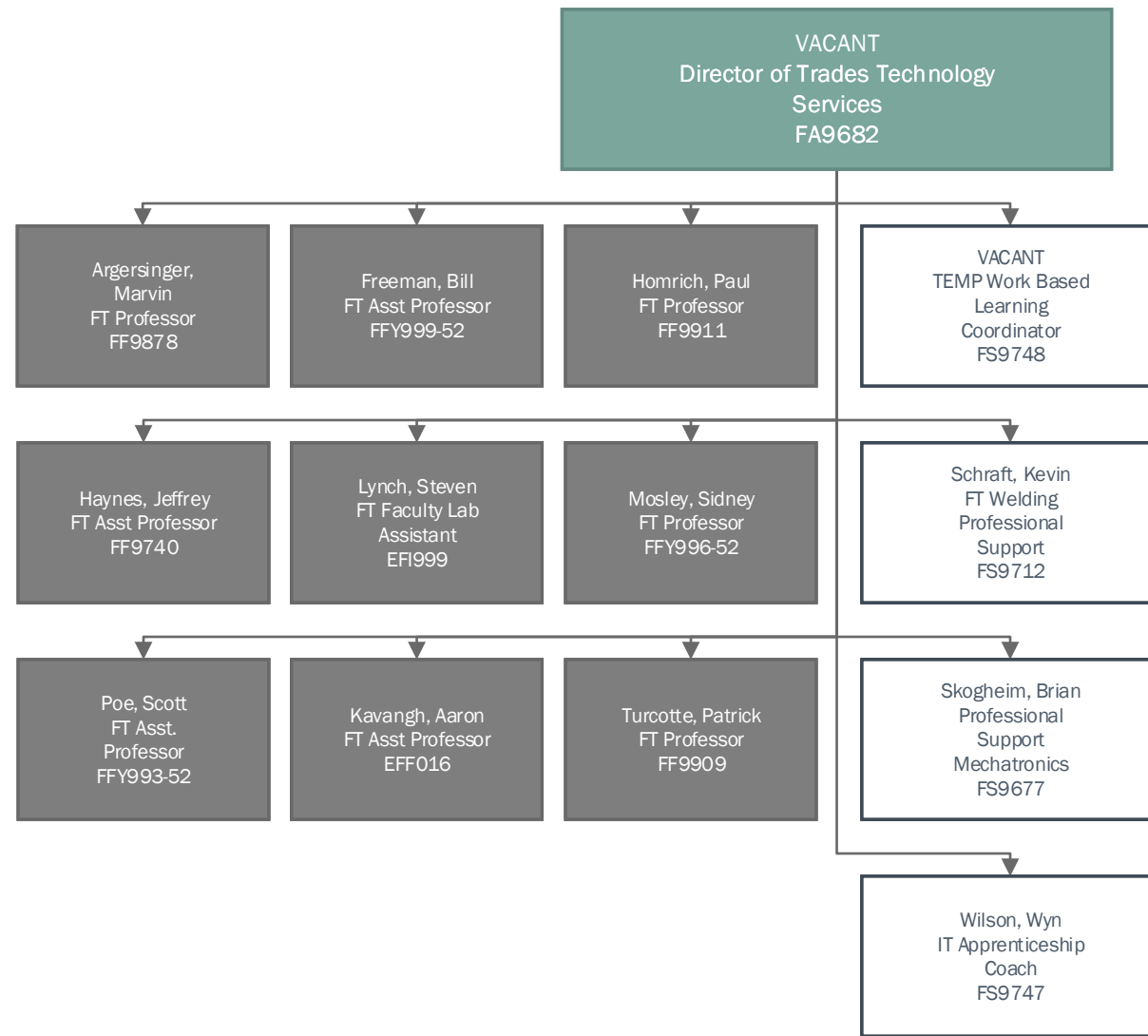
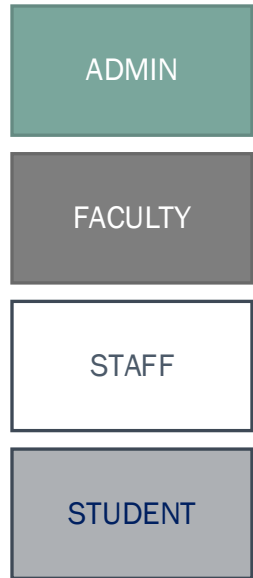

ADMIN

FACULTY

STAFF

STUDENT

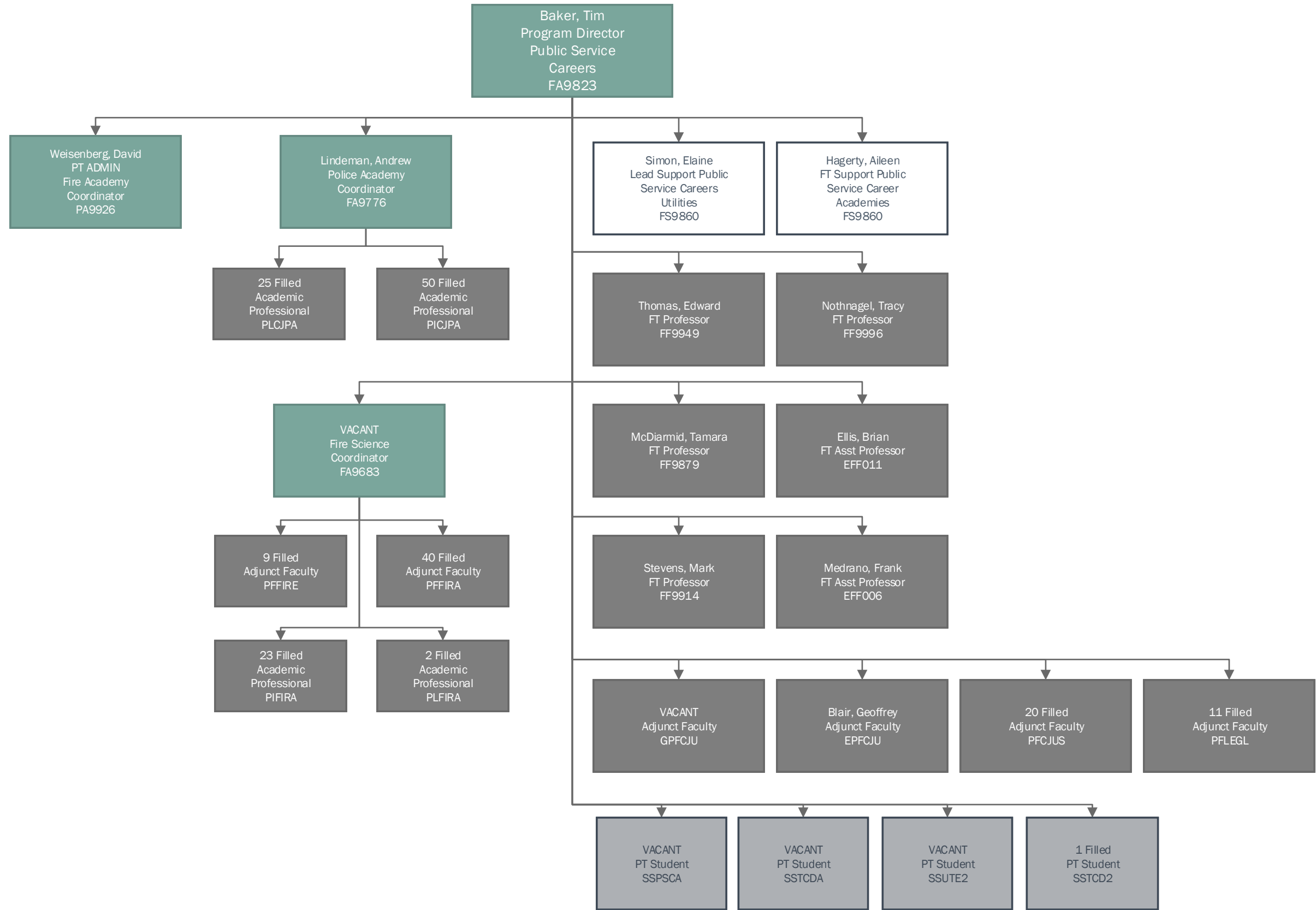

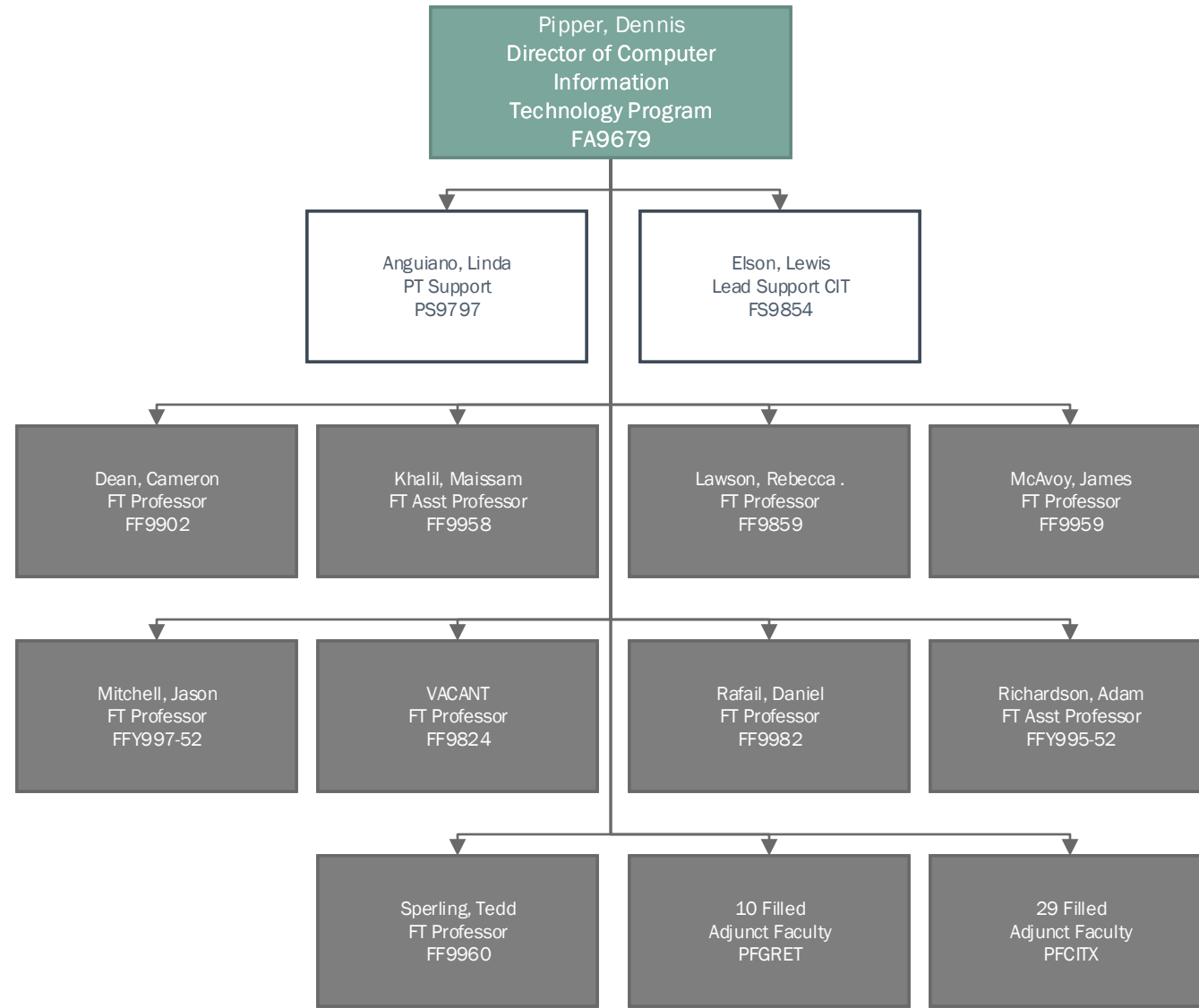
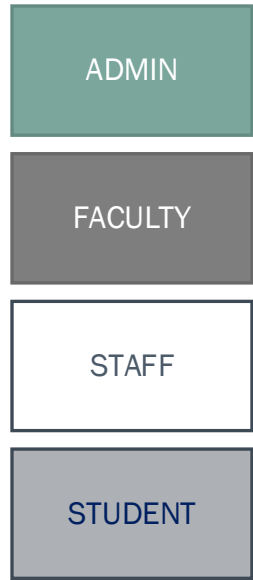

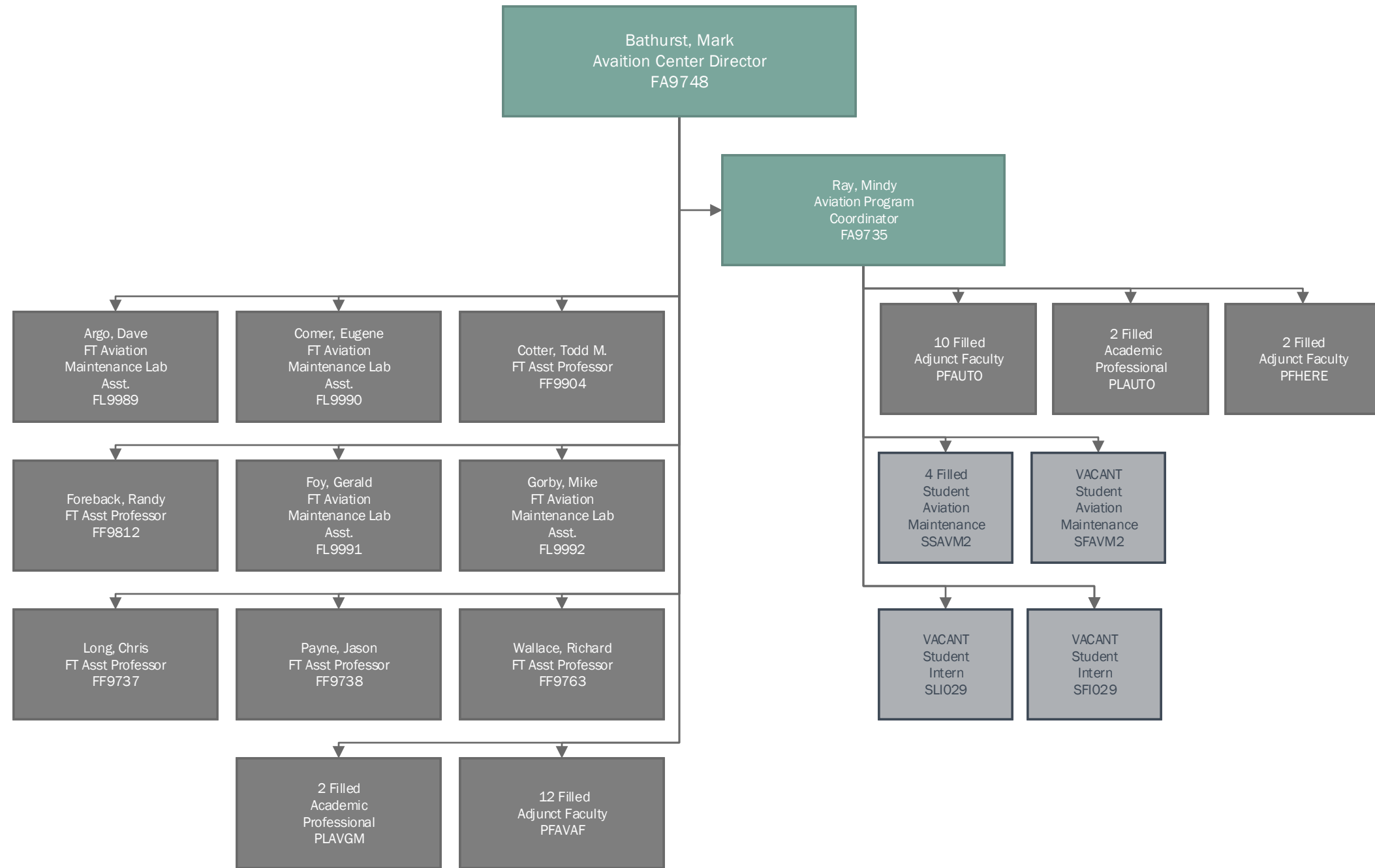
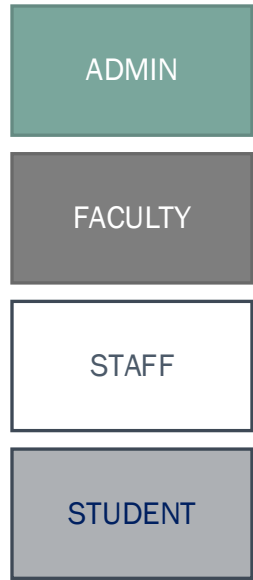

ADMIN

FACULTY

STAFF

STUDENT

